



Alüminyum Mimari Sistemler
Aluminium Architectural Systems

MİMARİ KATALOG ARCHITECTURAL CATALOGUE

Alüminyum Kapı Pencere ve Giydirme Cephe Sistemleri
Aluminium Door Window and Facade Systems



RGK35

MİMARİ KATALOG

ARCHITECTURAL CATALOGUE

Alüminyum Kapı Pencere ve Giydirme Cephe Sistemleri
Aluminium Window Doors and Facade Systems

RGK35

PROFİLLER

PROFILES

01

02

03

04

05

06

07

08

09

10

11

KOD / CODE	AĞIRLIK (kg/m) / WEIGHT	L m	KOD / CODE	AĞIRLIK (kg/m) / WEIGHT	L m
GK35 B 01	3,587	6			
GK35 B 03	0,761	6			



GK35 B 03

GK35 B 01

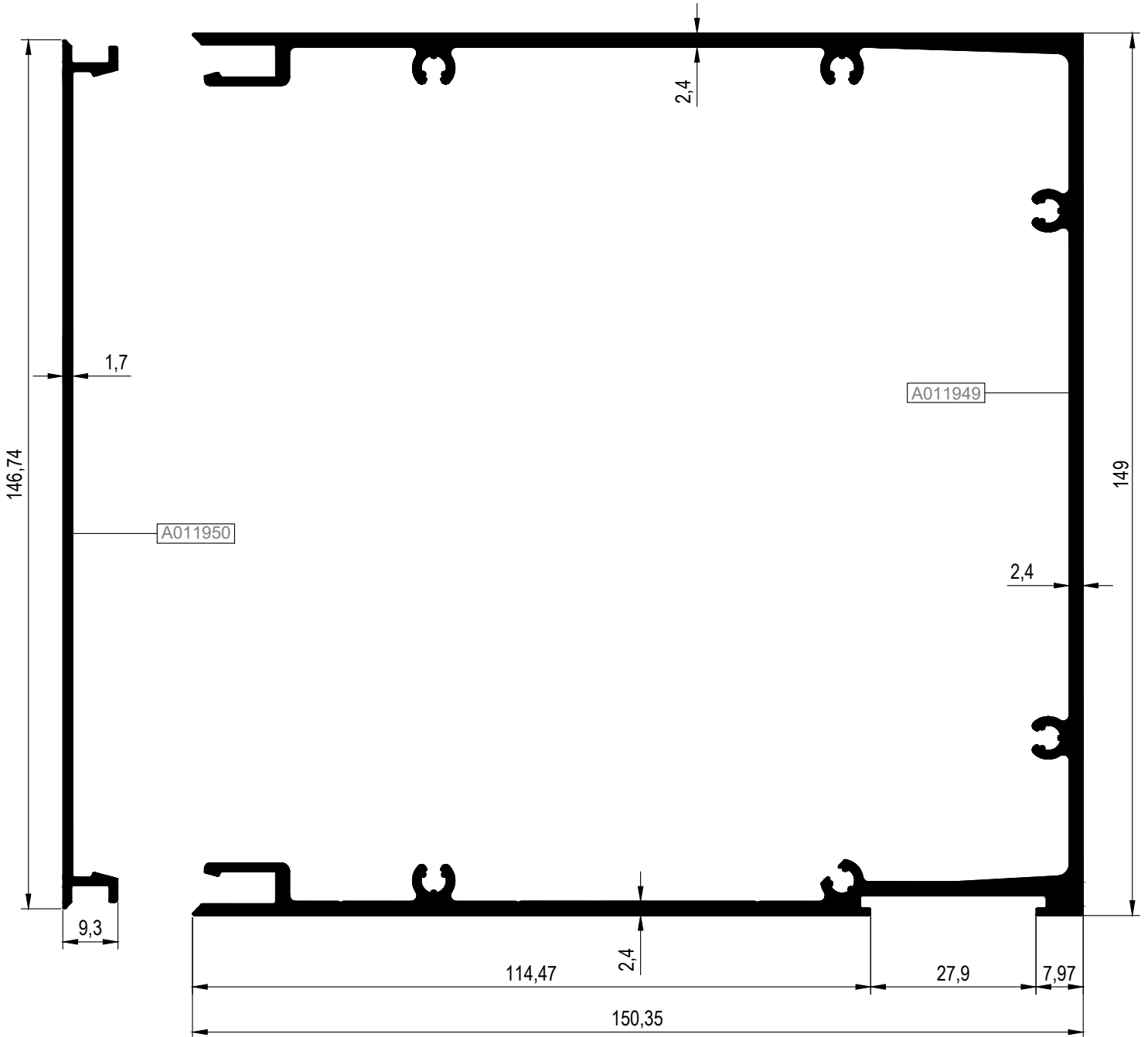

KOD / CODE	AĞIRLIK (kg/m) / WEIGHT	L m	KOD / CODE	AĞIRLIK (kg/m) / WEIGHT	L m
GK35 F 01	3,469	6			
GK35 F 02	2,066	6			



GK35 F 01

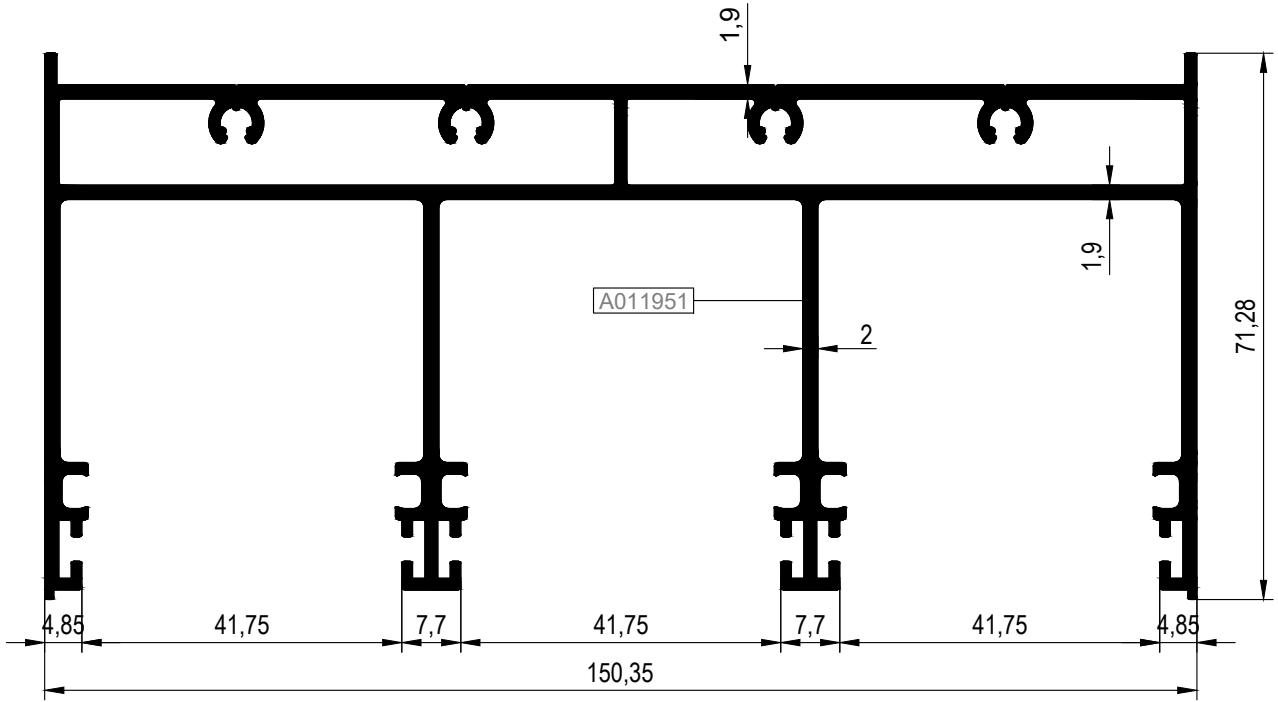

GK35 F 02

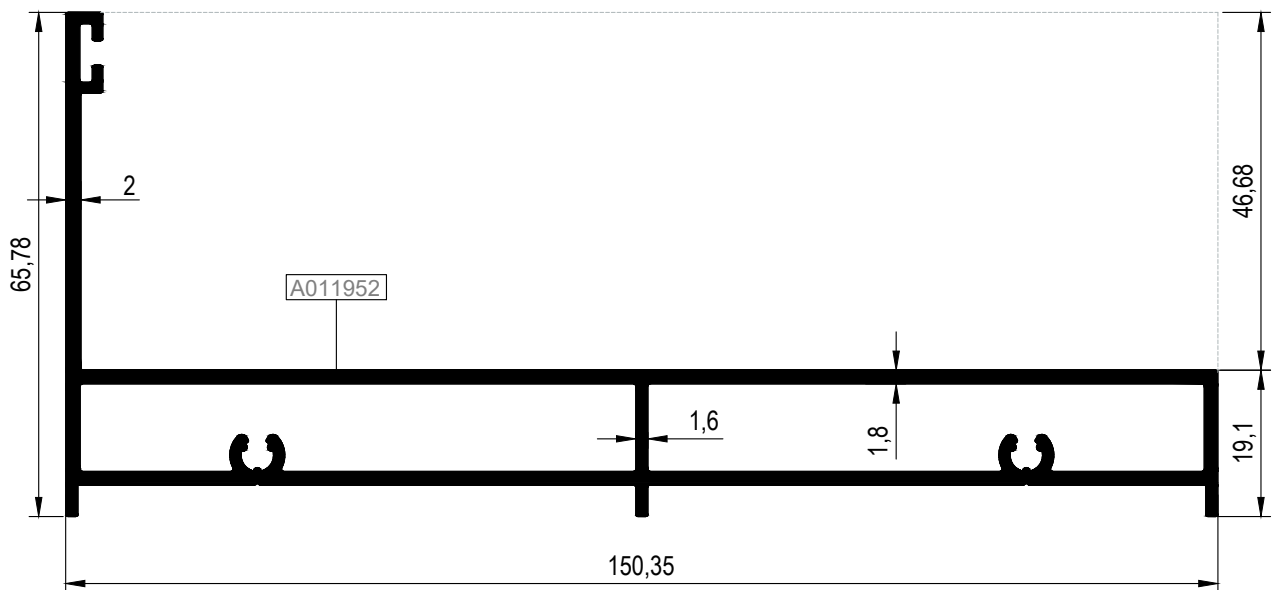

KOD / CODE	AĞIRLIK (kg/m) / WEIGHT	L m	KOD / CODE	AĞIRLIK (kg/m) / WEIGHT	L m
GK35 A 01	1,233	6	GK35 A 03	0,192	6
GK35 V 01	1,071	6			
GK35 G 01	0,149	6			
GK35 A 02	0,821	6			

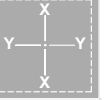

GK35 A 01

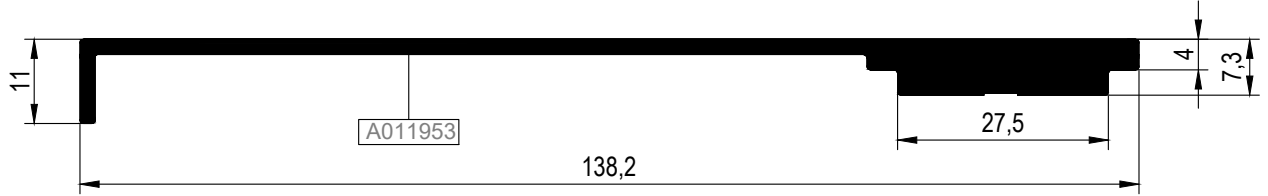

GK35 V 01

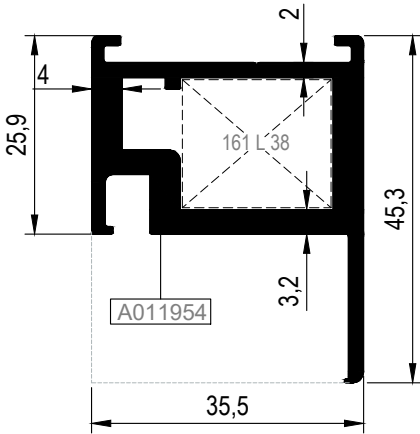

GK35 G 01

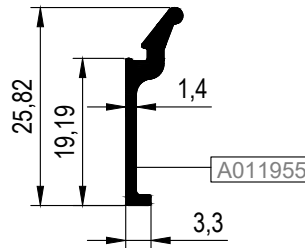

GK35 A 02

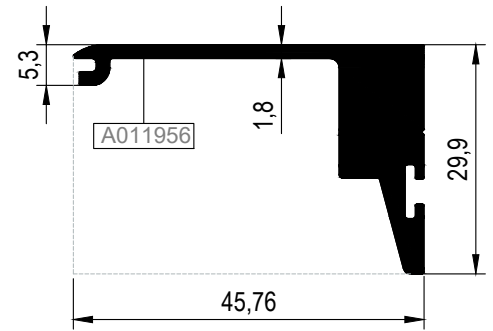

GK35 A 03

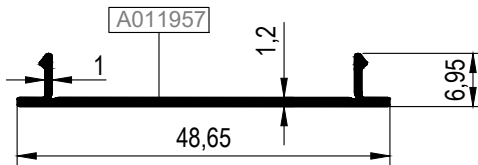

**GK35 G XX

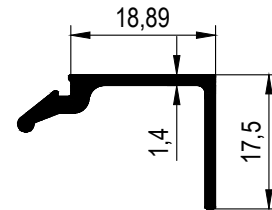

**Kalıp aktif değildir. Sipariş üzerine yapılacaktır.
The die is not active. It will be produced by order.

Nr		L m	KESİM ÖLÇÜSÜ CUTTING SIZE	AKS. KODU ACS. CODE
GK35 V01	A011954	25 L 38(A002074)	19,4 mm	161 L 38

KÖŞE TAKOZLARI (CORNER CLEATS)

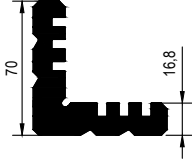
PROFİL KODU (PROFILE CODE)	25 L 38			
FABRİKA KODU (FACTORY CODE)	A002074			
AĞIRLIK (WEIGHT)	4,854 kg/m			
ÇİZİM (DRAWING)				

KÖŞE TAKOZLARI (CORNER CLEATS)

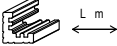
Nr		KESİM ÖLÇÜSÜ CUTTING SIZE	AKS. KODU ACS. CODE
GK35 V01	A011954	25 L 38(A002074)	19,4 mm
			161 L 38

MİMARİ KATALOG

ARCHITECTURAL CATALOGUE

Alüminyum Kapı Pencere ve Giydirme Cephe Sistemleri
Aluminium Window Doors and Facade Systems

RGK35

DETAYLAR

DETAILS

01

02

03

04

05

06

07

08

09

10

11

ÇİFT CAMLI DETAYLAR
DOUBLE GLAZED DETAILS

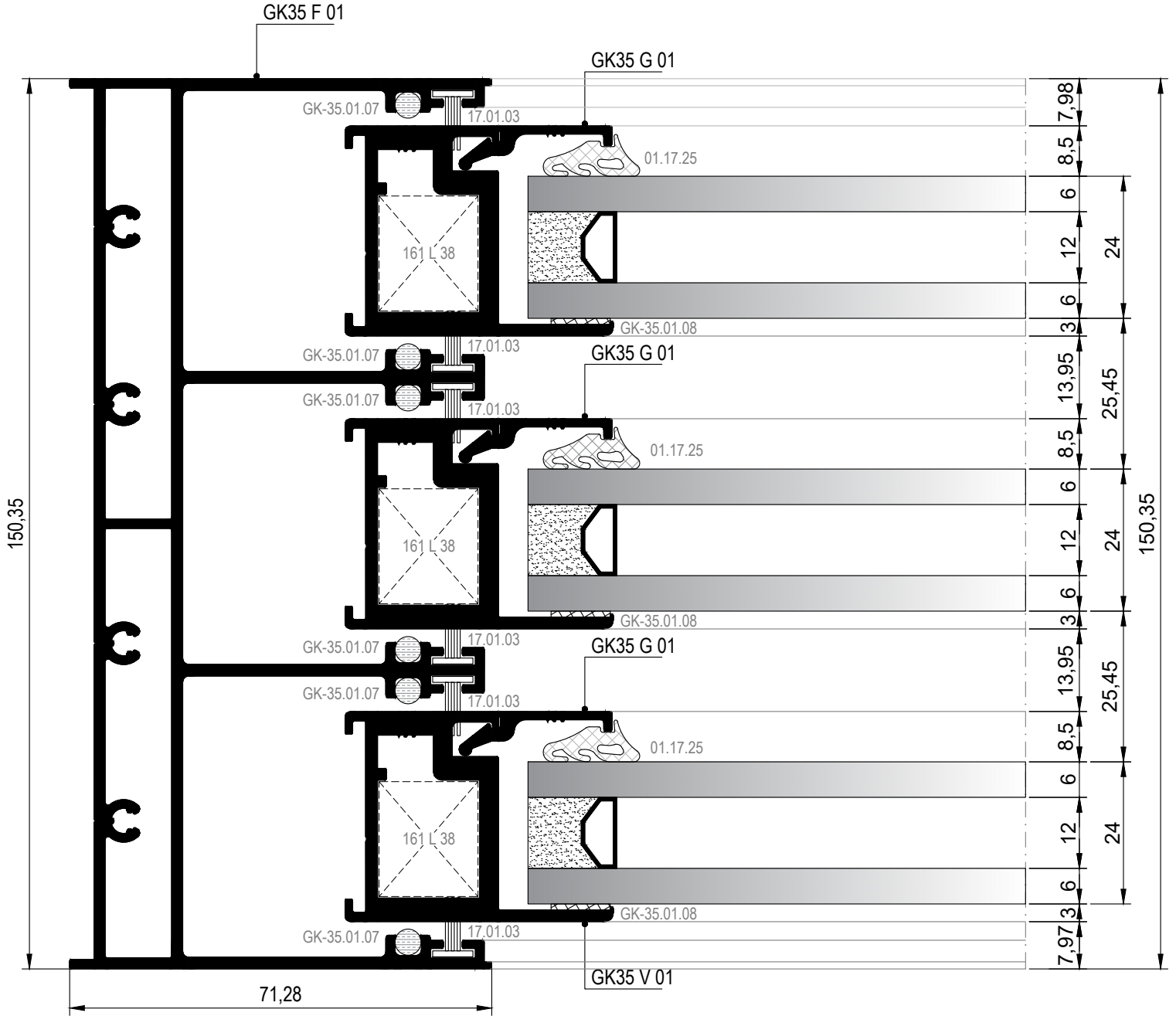
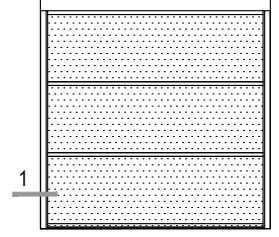

① DETAYI
DETAIL

ÇİFT CAMLI DETAYLAR
DOUBLE GLAZED DETAILS

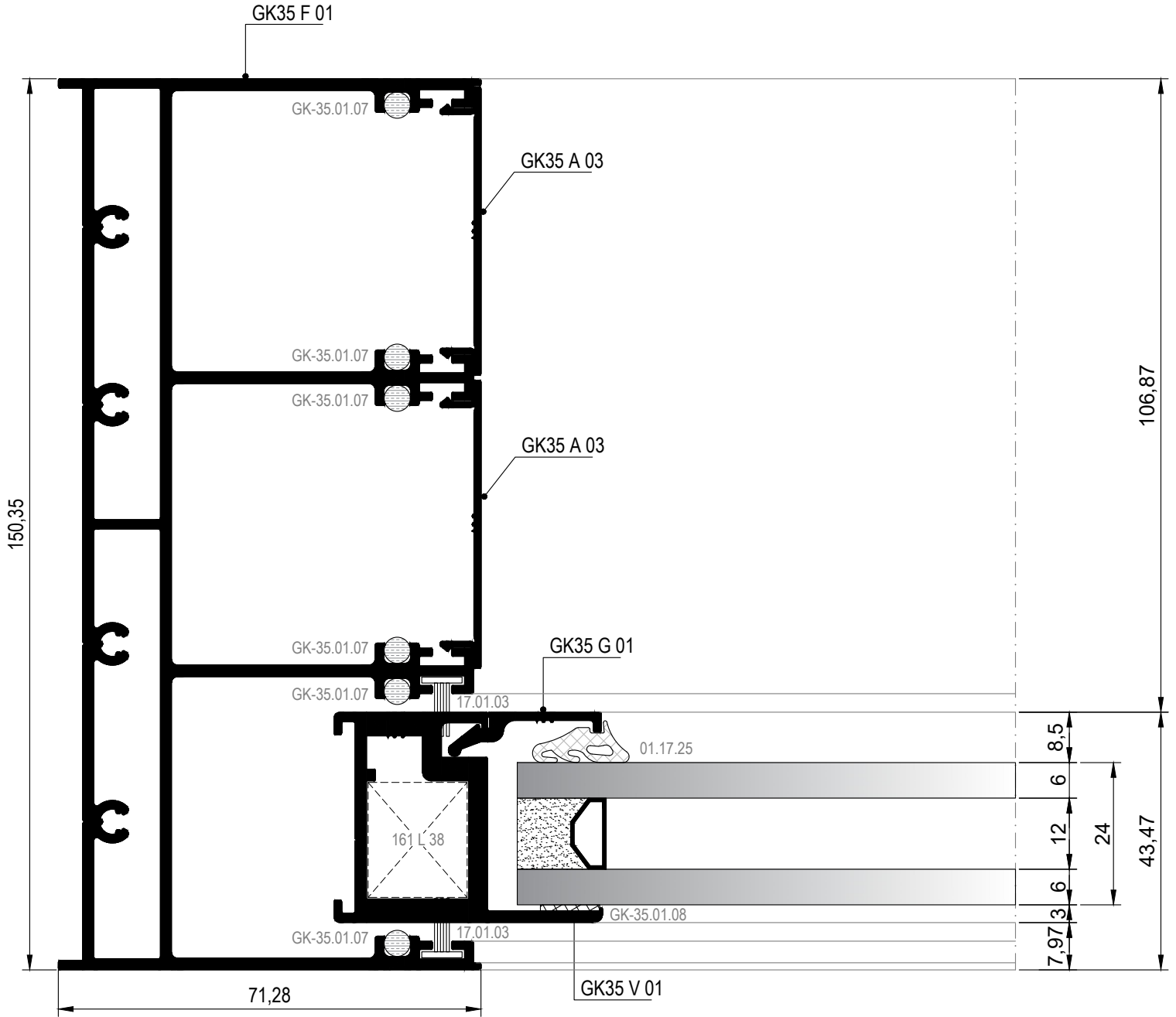
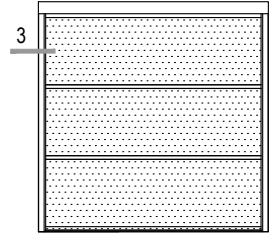

③ DETAYI
DETAIL

ÇİFT CAMLI DETAYLAR
DOUBLE GLAZED DETAILS

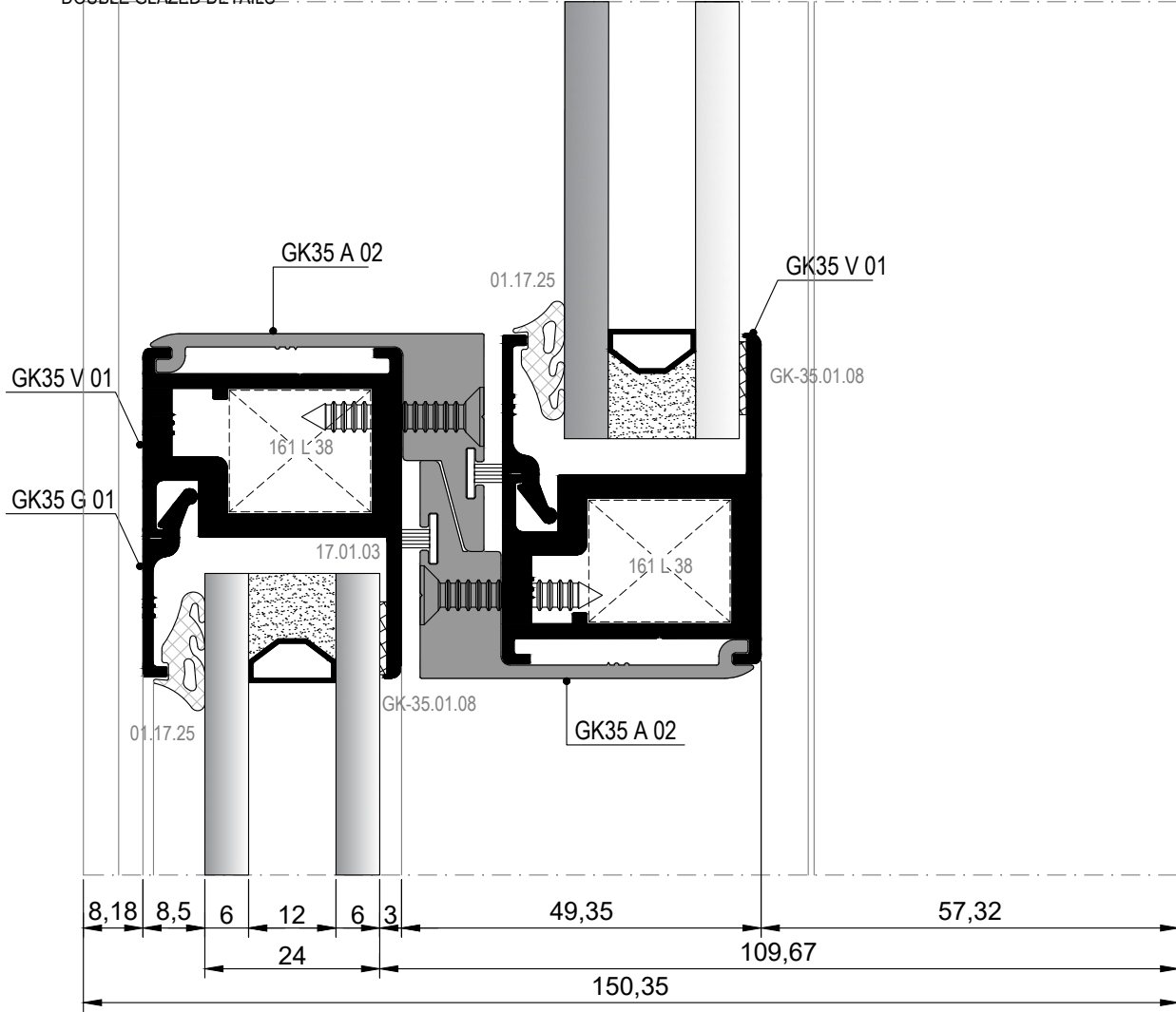
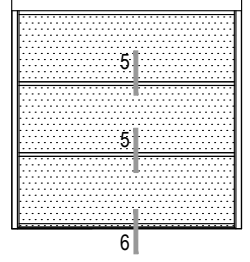

⑤ DETAYI
DETAIL

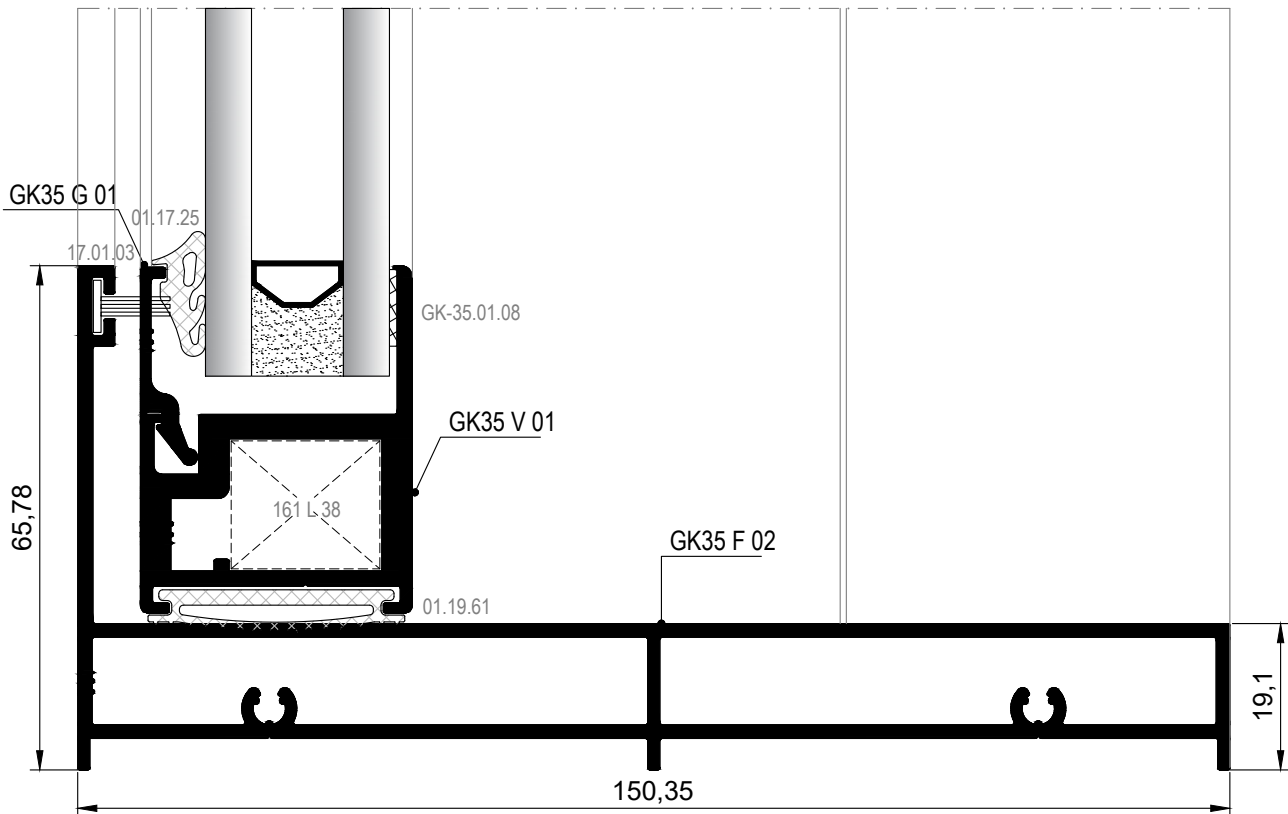

⑥ DETAYI
DETAIL

TEK CAMLI DETAYLAR (10 mm)
SINGLE GLAZED DETAILS (10 mm)

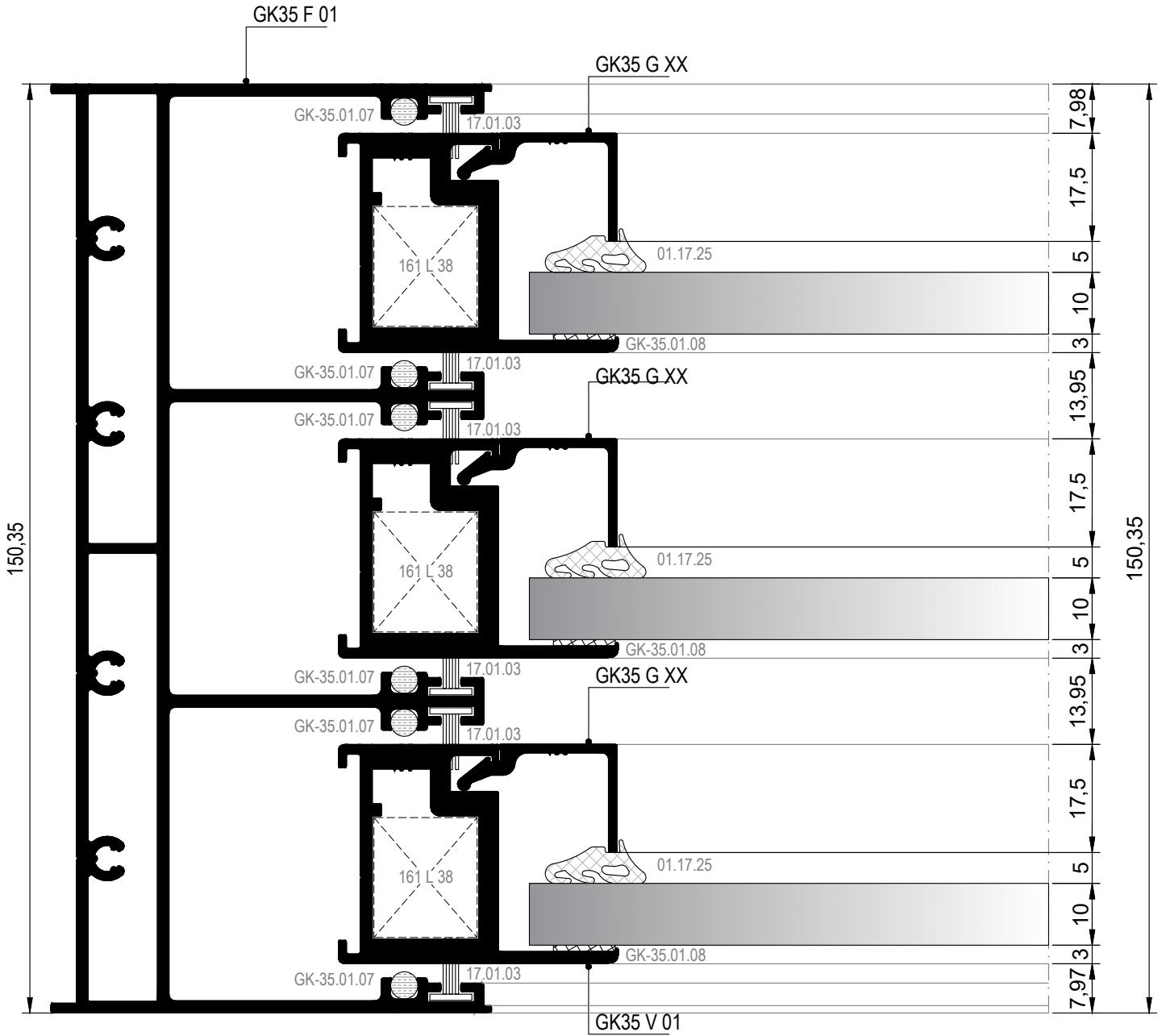
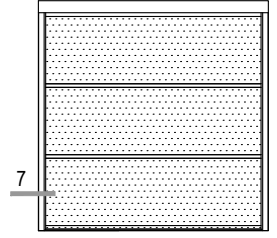

7 DETAYI
DETAIL

TEK CAMLI DETAYLAR (10 mm)
SINGLE GLAZED DETAILS (10 mm)

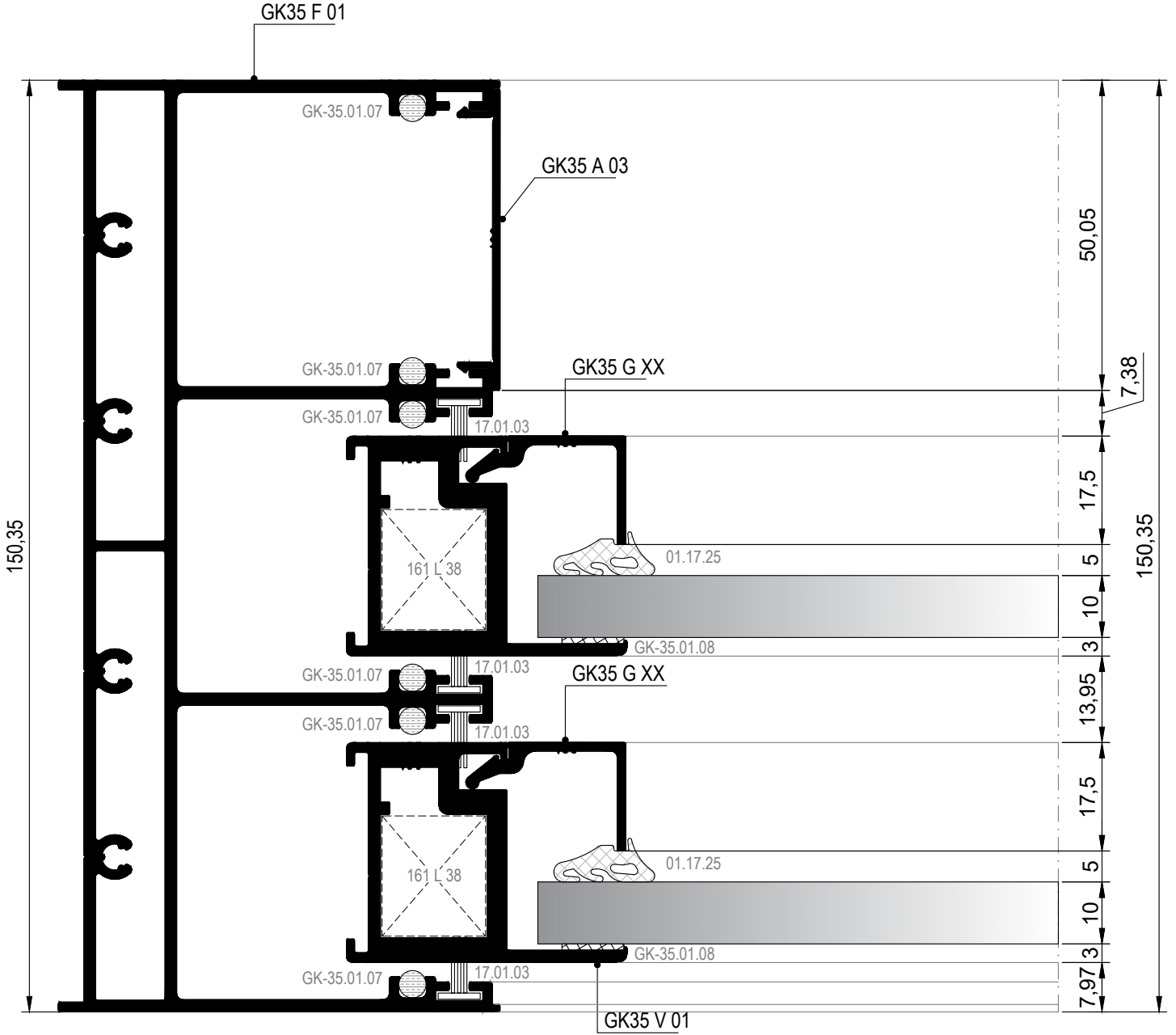
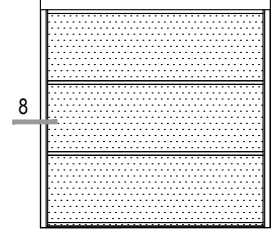

8 DETAYI
DETAIL

TEK CAMLI DETAYLAR (10 mm)
SINGLE GLAZED DETAILS (10 mm)

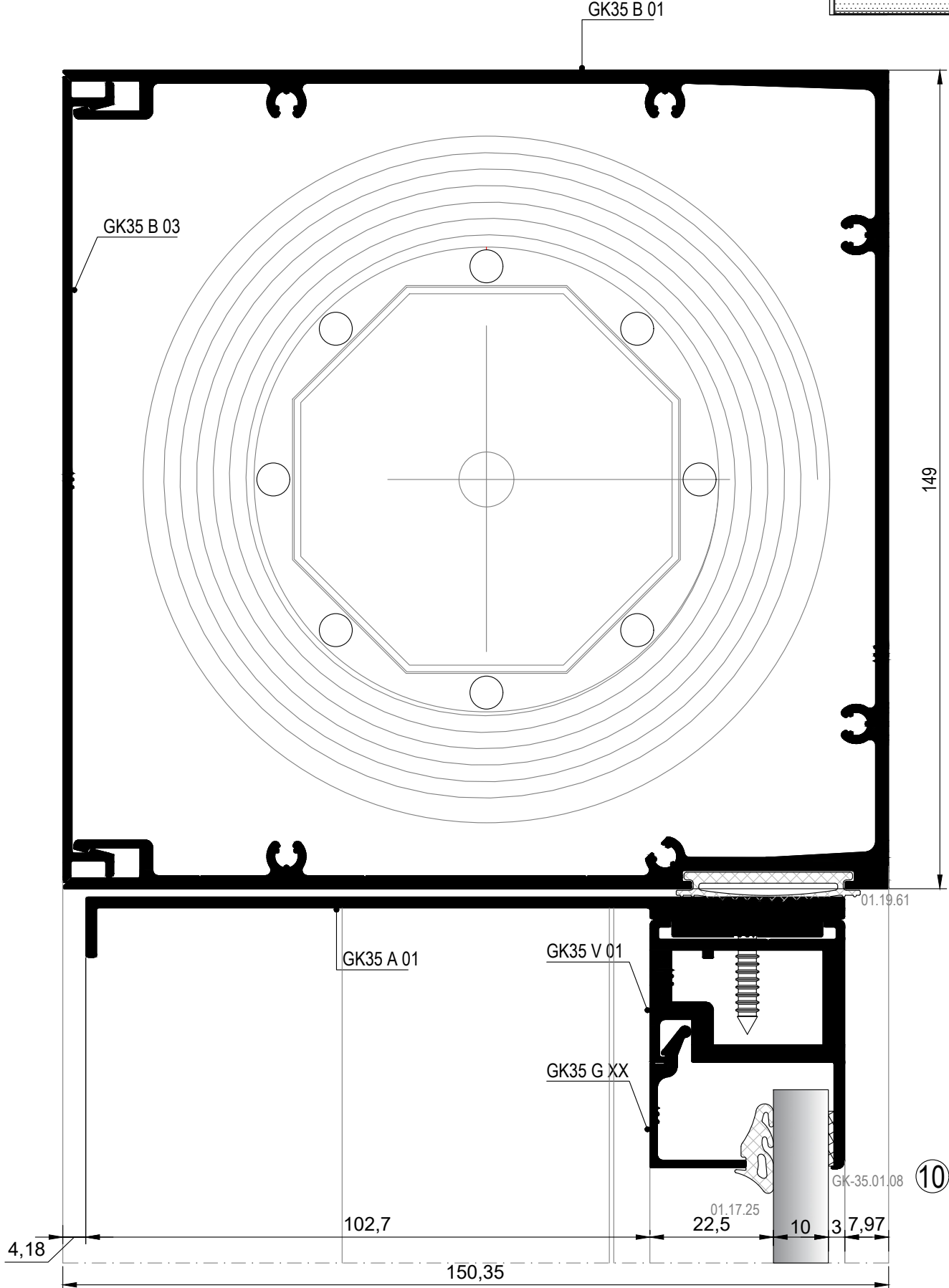
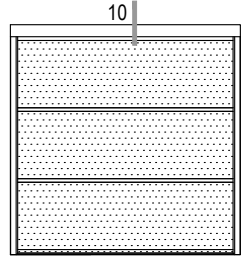

TEK CAMLI DETAYLAR (10 mm)
SINGLE GLAZED DETAILS (10 mm)

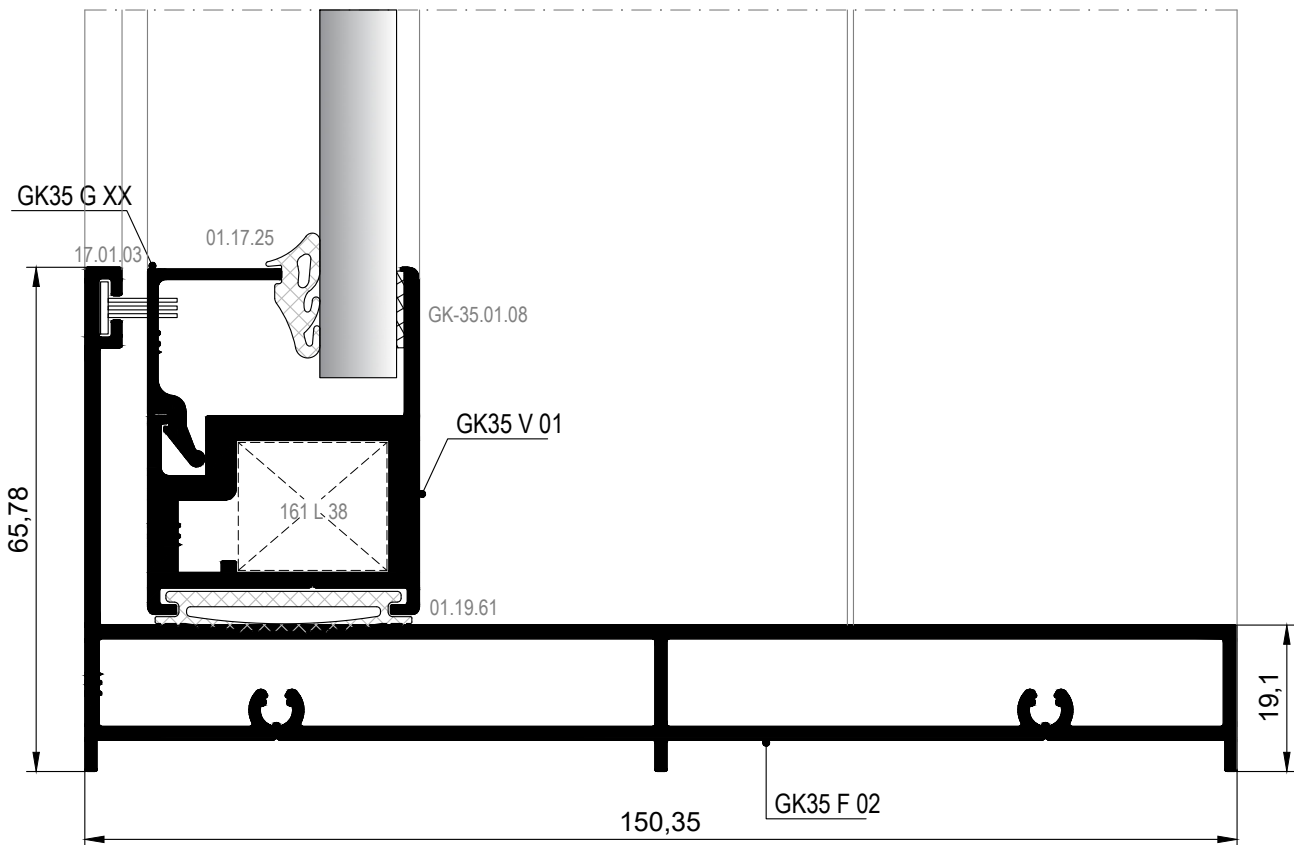
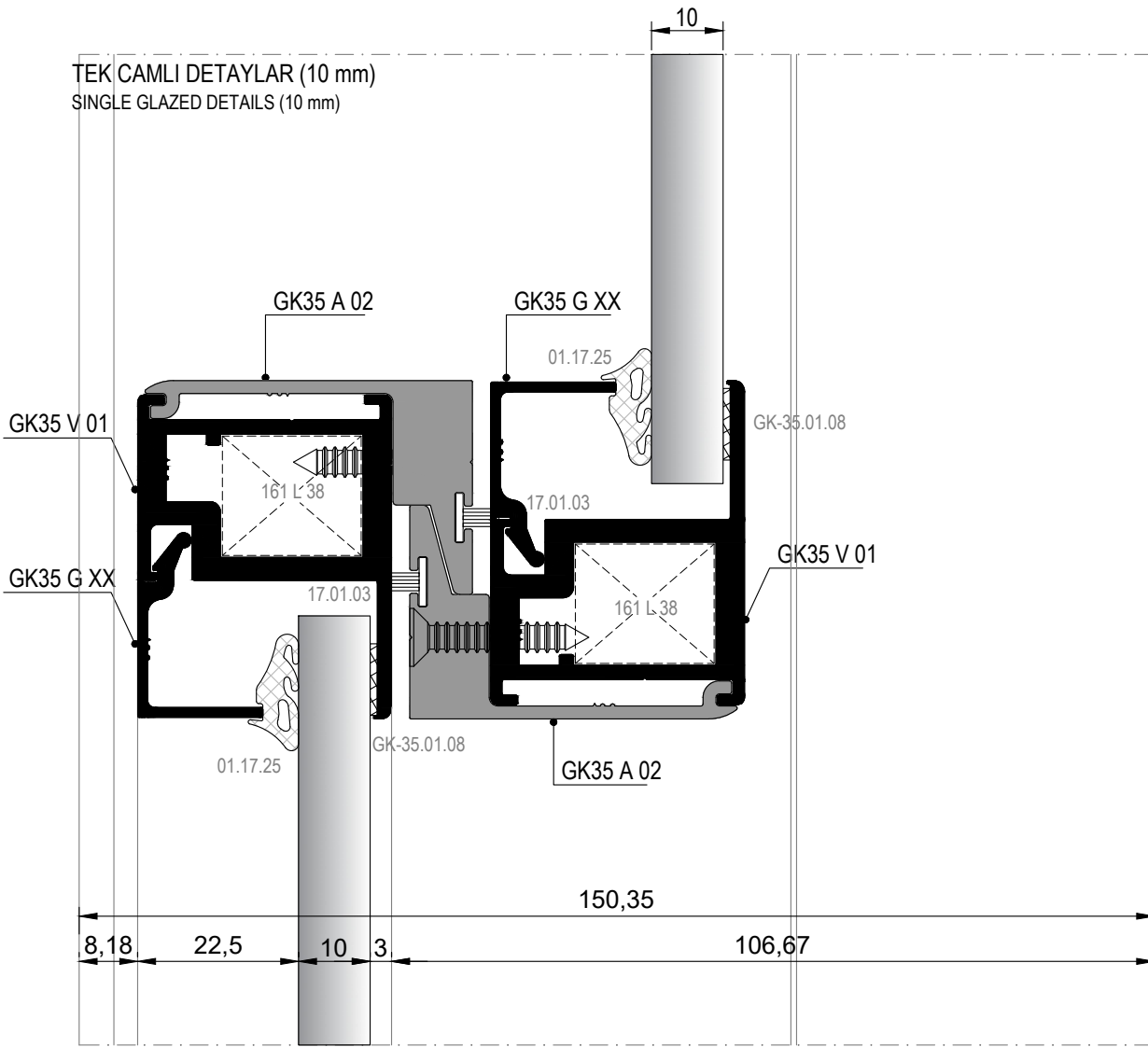
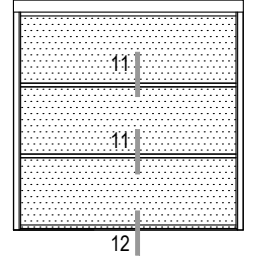

TEK CAMLI DETAYLAR (8 mm)
SINGLE GLAZED DETAILS (8 mm)

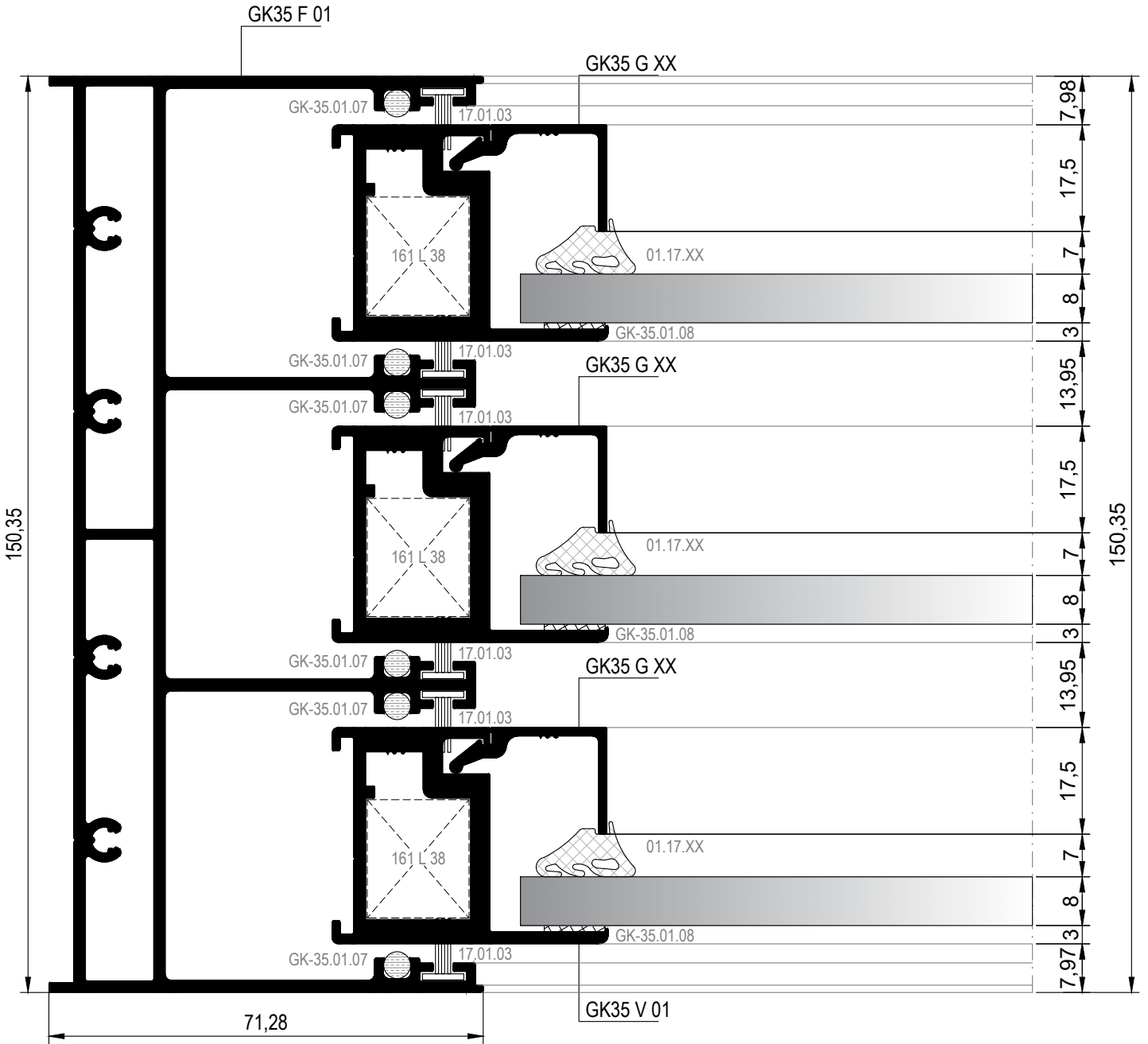
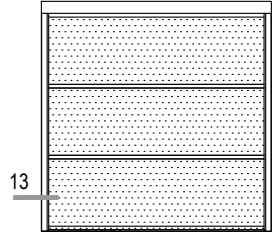

TEK CAMLI DETAYLAR (8 mm)
SINGLE GLAZED DETAILS (8 mm)

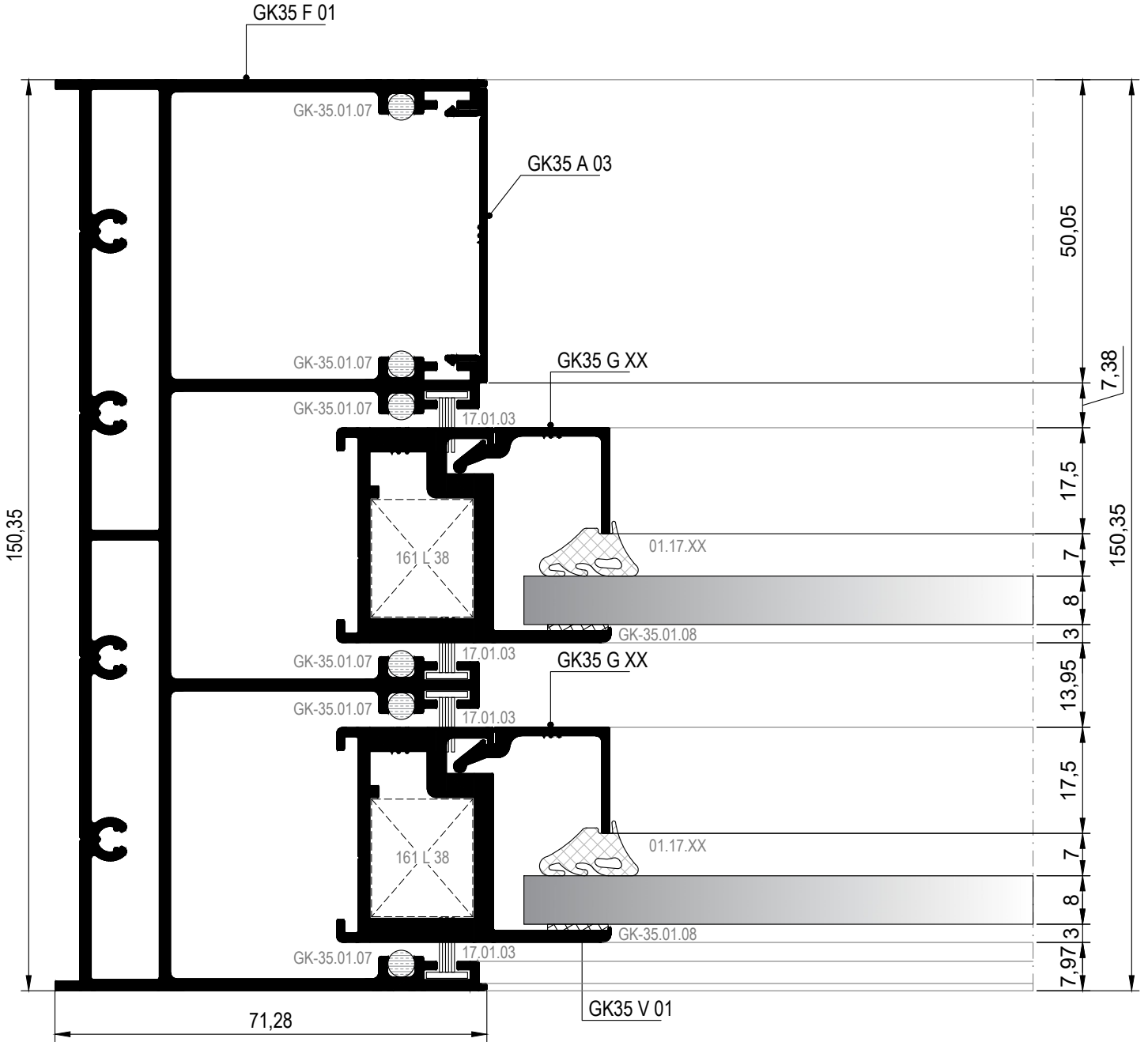
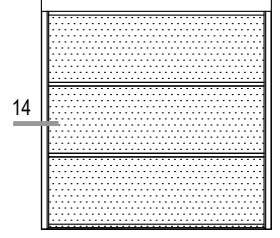

TEK CAMLI DETAYLAR (8 mm)
SINGLE GLAZED DETAILS (8 mm)

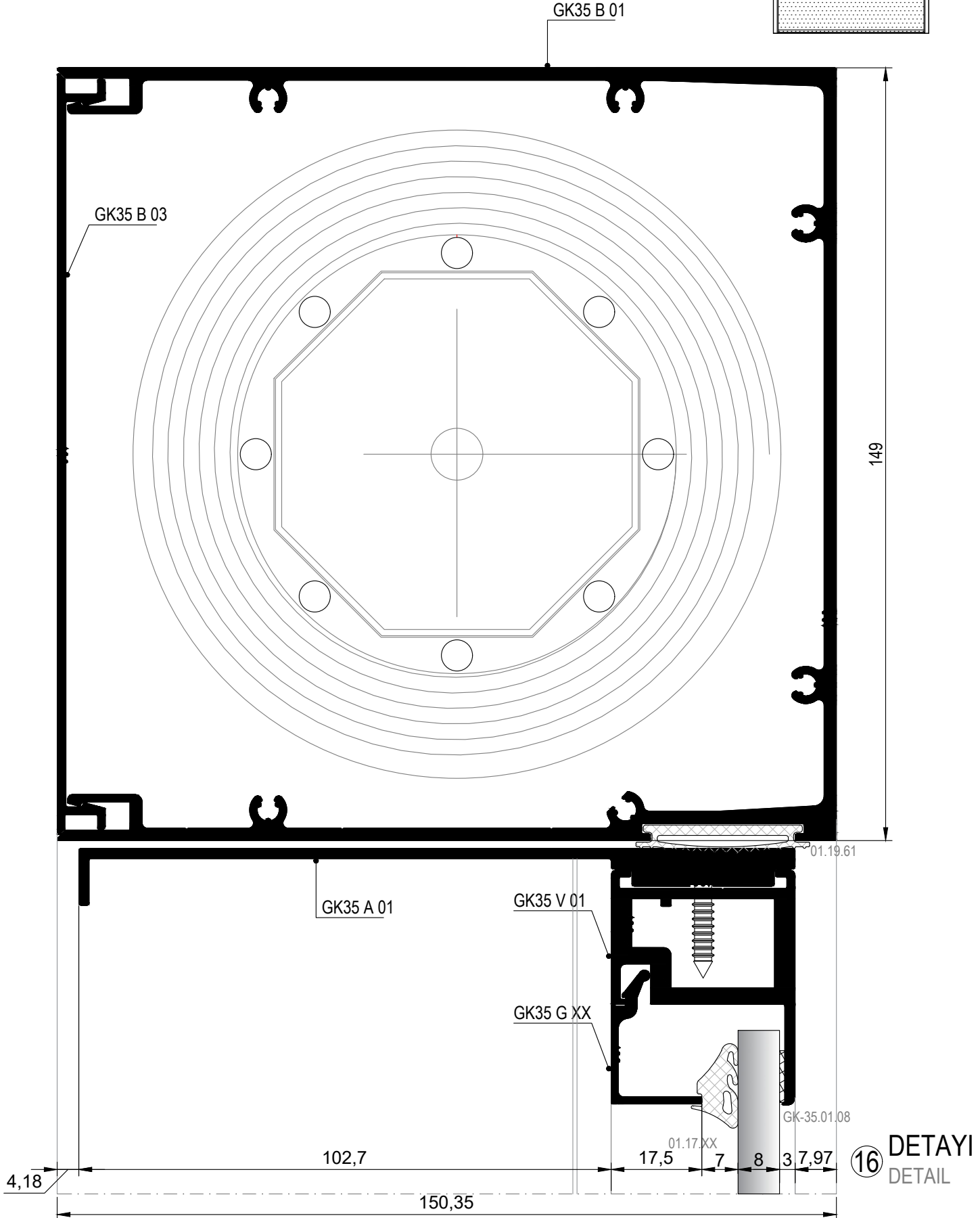
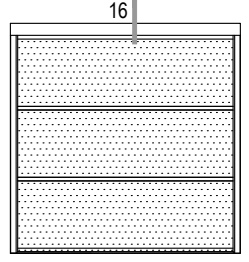

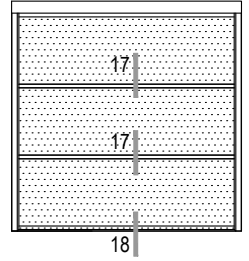
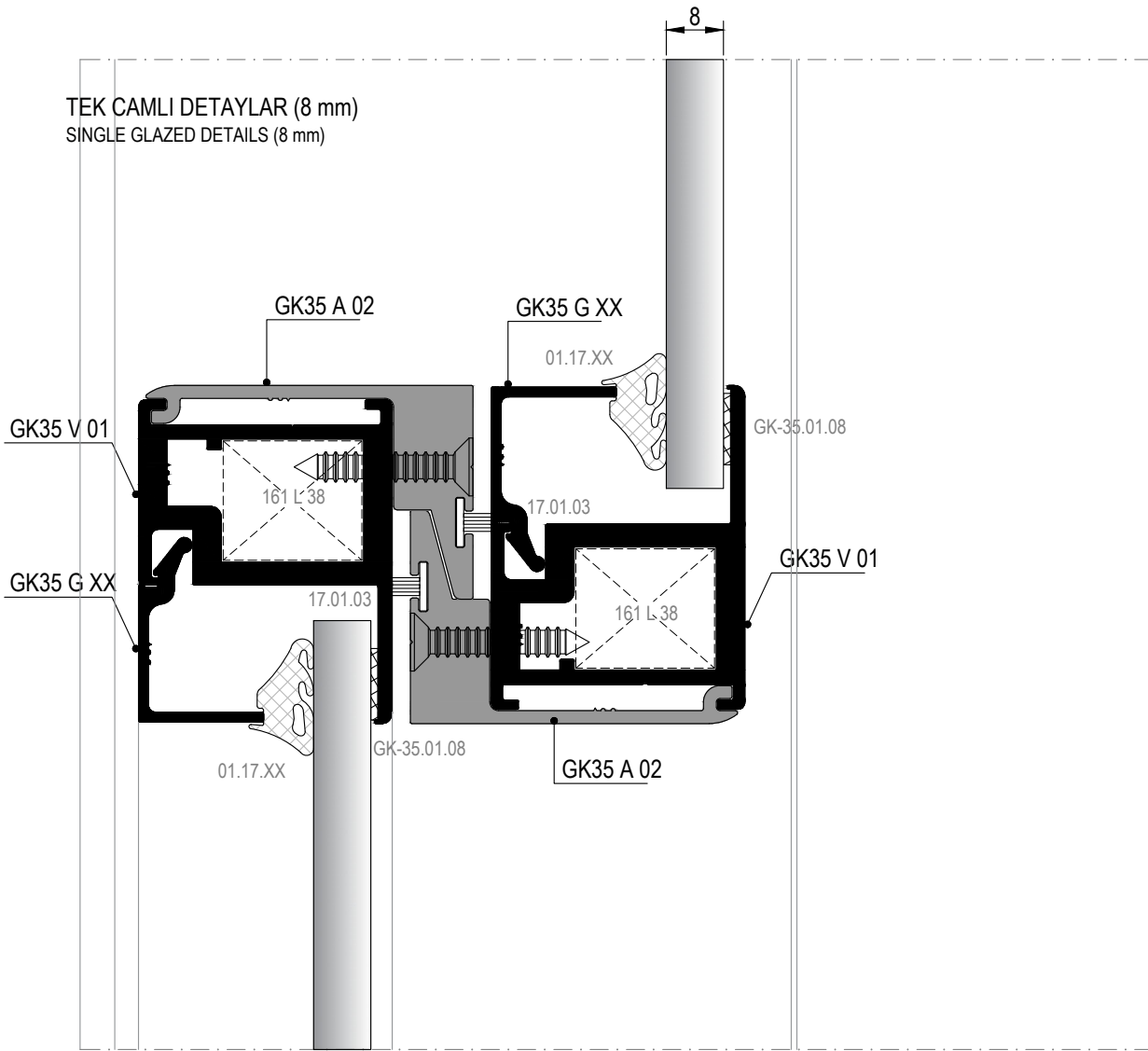

17 DETAYI
DETAIL

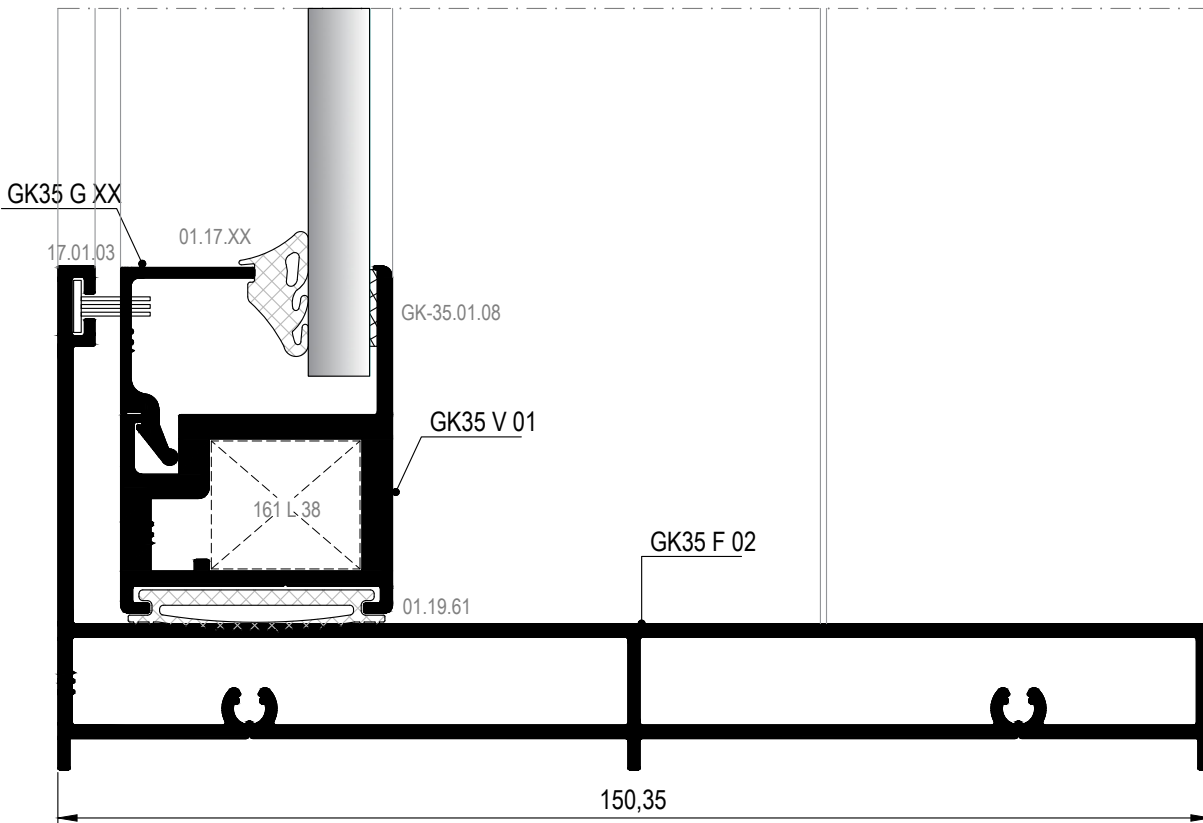

18 DETAYI
DETAIL

MİMARİ KATALOG
ARCHITECTURAL CATALOGUE

Alüminyum Kapı Pencere ve Giydirme Cephe Sistemleri
Aluminium Window Doors and Facade Systems

RGK35

AKSESUARLAR

ACCESSORIES

01

02

03

04

05

06







07



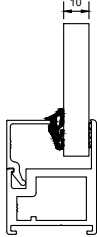

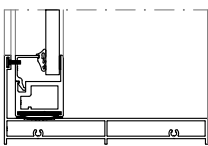
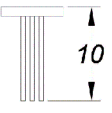
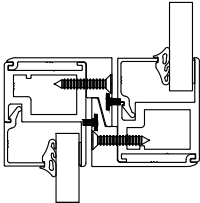

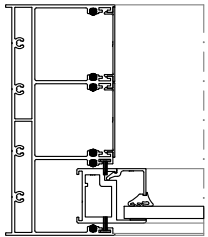

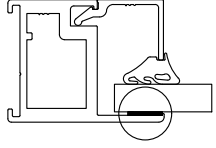
08

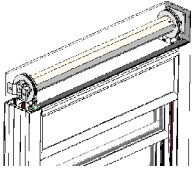
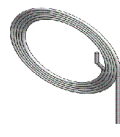
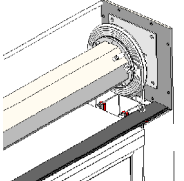
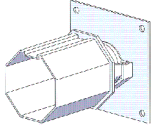
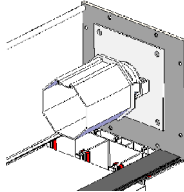
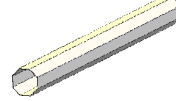
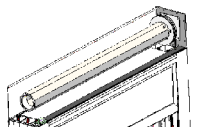
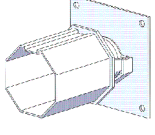
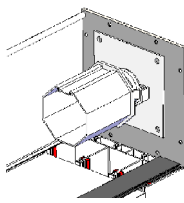
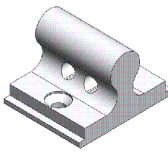
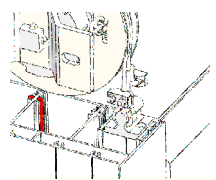
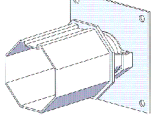
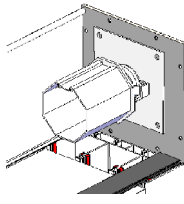
09

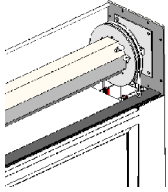
10

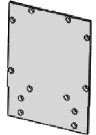
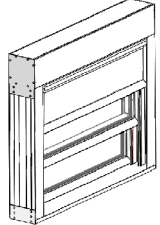
11

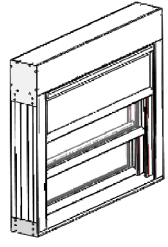
	<p>01.17.25 İÇ CAM FİTİLİ INSIDE GLAZING GASKET</p> <p>Malzeme / Material : EPDM Ağırlık / Weight : 77 gr/m Paket / Package: 194,8 m / 15 kg</p>				
	<p>01.19.61 ALT ÜST KASA FİTİLİ DOWN UP FRAME GASKET</p> <p>Malzeme / Material : EPDM Ağırlık / Weight : 131 gr/m Paket / Package: 114,5 m / 15 kg</p>				
	<p>17.01.03 KİL FİTİL 67x1000 BRUSH</p> <p>Malzeme / Material Polipropilen / Polipropilene Paket / Package: 800 m</p>				
	<p>GK-35.01.07 FİTİL Ø4,5 GASKET Ø4,5</p> <p>Malzeme / Material : Polioksimetilen Paket / Package: 3 m</p>				
	<p>GK-35.01.08 ÇİFT TARAF LI RULO BANT DOUBLE SIDED ROLL TAPE</p> <p>10mmx1mm Paket / Package: 50m</p>				

	GK-35.01.01 NATUROLL TÜP MOTOR NATUROLL TUBE MOTOR			GK-35.01.05 ÇELİK HALAT STEEL ROPE Ø3, 4adet x 2,5m Çelik Halat 250 kg dayanıklı	
	GK-35.01.02A TÜP MOTOR BAĞLANTI AKSESUARI TUBE MOTOR CONNECTION ACCESSORIES Paket/Package:1 takım			GK-35.01.06 TAMBUR BORUSU DRUM PIPE 6500 mm	
	GK-35.01.02B TÜP MOTOR BAĞLANTI AKSESUARI TUBE MOTOR CONNECTION ACCESSORIES Paket/Package:1 takım			GK-35.01.11 HALAT TAŞIMA PARÇASI ROPE CARRYING PARTS	
	GK-35.01.02C TÜP MOTOR BAĞLANTI AKSESUARI TUBE MOTOR CONNECTION ACCESSORIES Paket/Package:1 takım			GK-35.01.12 NATUROLL TÜP MOTOR KUMANDASI NATUROLL TUBE MOTOR REMOTE CONTROL	TEK KANALLI VERİCİ TRANSMITTER, SINGLE CHANNEL
	GK-35.01.03 KASNAK GRUBU PULLEY GROUP Paket/Package:1 takım(2 kasnak grubu)			GK-35.01.13 NATUROLL TÜP MOTOR KUMANDASI NATUROLL TUBE MOTOR REMOTE CONTROL	TEK TEK VEYA GRUP KONTROL ÖZELLİĞİ OLAN 4 KANALLI VERİCİ TRANSMITTER, 4 CHANNELS, INDIVIDUAL AND GROUP CONTROL FUNCTION
	GK-35.01.04-1 YAN KAPAKLAR(üst) SIDE CAPS			GK-35.01.14 NATUROLL TÜP MOTOR KUMANDASI NATUROLL TUBE MOTOR REMOTE CONTROL	TEK TEK VEYA GRUP KONTROL ÖZELLİĞİ OLAN LCD EKРАНLI 4 KANALLI VERİCİ TRANSMITTER, 4 CHANNELS, LCD DISPLAY, INDIVIDUAL AND GROUP CONTROL FUNCTION
	GK-35.01.04-2 YAN KAPAKLAR(alt) SIDE CAPS			GK-35.01.15 NATUROLL TÜP MOTOR KUMANDASI NATUROLL TUBE MOTOR REMOTE CONTROL	TEK TEK VEYA GRUP KONTROL ÖZELLİĞİ OLAN LCD EKРАНLI 8 KANALLI VERİCİ TRANSMITTER, 8 CHANNELS, LCD DISPLAY, INDIVIDUAL AND GROUP CONTROL FUNCTION

	GK-35.01.16 NATUROLL TÜP MOTOR KUMANDASI NATUROLL TUBE MOTOR REMOTE CONTROL	TEK TEK VEYA GRUP KONTROL ÖZELLİĞİ OLAN LCD EKANLI 16 KANALLI VERİCİ TRANSMITTER, 16 CHANNELS, LCD DISPLAY, INDIVIDUAL AND GROUP CONTROL FUNCTION			
	GK-35.01.17 NATUROLL TÜP MOTOR KUMANDASI NATUROLL TUBE MOTOR REMOTE CONTROL	TEK KANALLI 8 FARKLI AÇMA KAPAMALI ZAMAN AYARLAYICI LCD EKANLI VERİCİ TRANSMITTER, SINGLE CHANNEL, LCD DISPLAY, TIMER FUNCTION, 8 DIFFERENT OPEN&CLOSE TIME			
	GK-35.01.18 NATUROLL TÜP MOTOR KUMANDASI NATUROLL TUBE MOTOR REMOTE CONTROL	TEK TEK VEYA 4 KANALLI 8 FARKLI AÇMA KAPAMALI ZAMAN AYARLAYICI LCD EKANLI VERİCİ TRANSMITTER, 4 CHANNELS, LCD DISPLAY, TIMER FUNCTION, 8 DIFFERENT OPEN&CLOSE TIME			
	GK-35.01.19 NATUROLL TÜP MOTOR KUMANDASI ALICISI NATUROLL TUBE MOTOR REMOTE CONTROL RECEIVER	GARAJ TİPİ DUVAR ALICI RECEIVER FOR GARAGE DOOR APPLICATION			

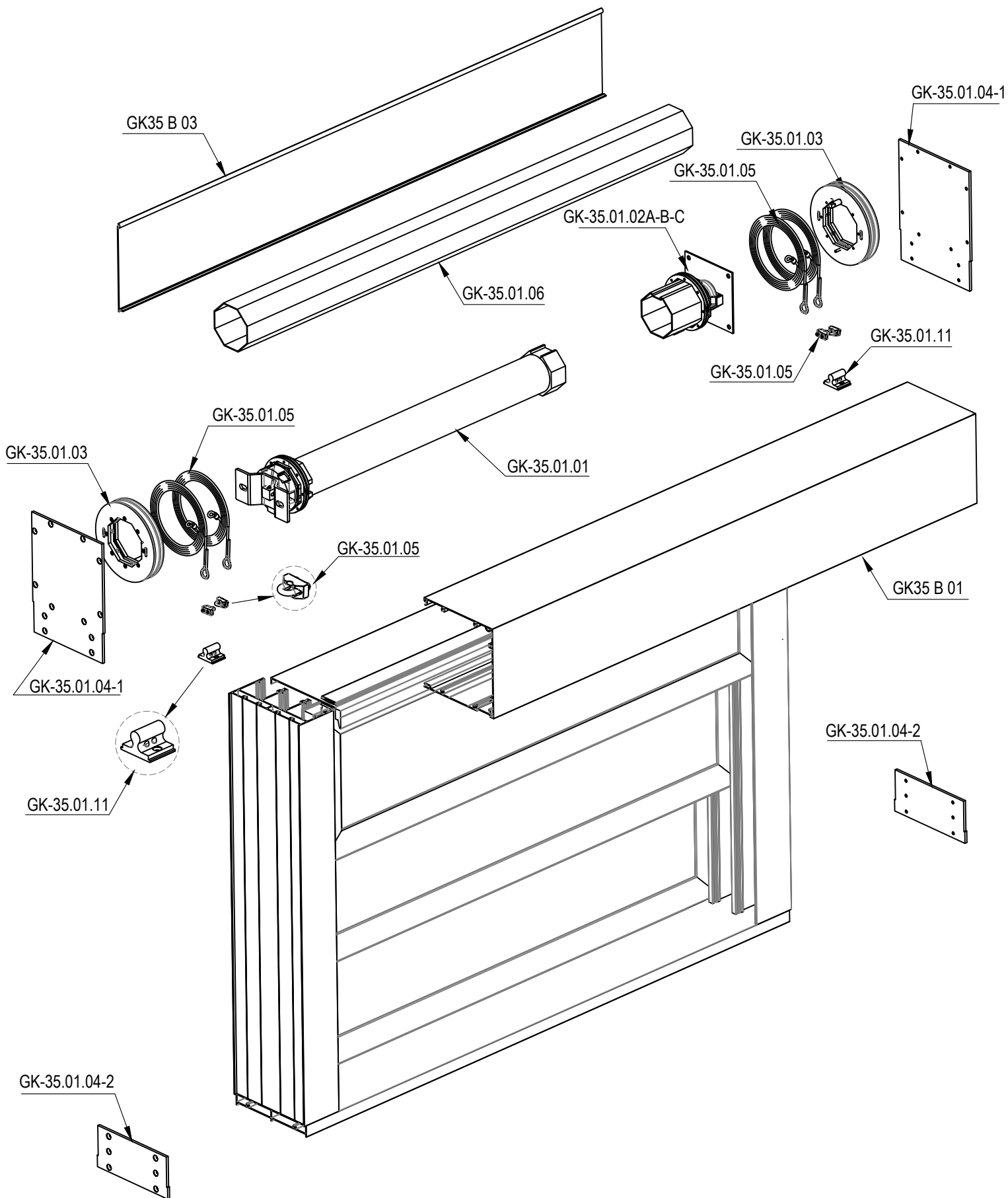

HAREKET MEKANİZMASI SETİ
MOVEMENT MECHANISM SET

	KOD CODE	TANIM DESCRIPTION	ADET NUMBER	TAKIM SET
1	GK-35.01.01	TÜP MOTOR TUBE MOTOR	1	
2	GK-35.01.02A	TÜP MOTOR BAĞLANTI AKSESUARI TUBE MOTOR CONNECTION ACCESSORIES		1
3	GK-35.01.02B	TÜP MOTOR BAĞLANTI AKSESUARI TUBE MOTOR CONNECTION ACCESSORIES		1
4	GK-35.01.02C	TÜP MOTOR BAĞLANTI AKSESUARI TUBE MOTOR CONNECTION ACCESSORIES		1
5	GK-35.01.03	KASNAK GRUBU PULLEY GROUP		1
6	GK-35.01.04-1	YAN KAPAKLAR(ÜST) SIDE CAPS (UP)	2	
7	GK-35.01.04-2	YAN KAPAKLAR(ALT) SIDE CAPS (DOWN)	2	
8	GK-35.01.05	ÇELİK HALAT STEEL ROPE	4	
9	GK-35.01.06	TAMBUR BORUSU - 6500 mm DRUM PIPE - 6500 mm	1	
10	GK-35.01.11	HALAT TAŞIMA MEKANİZMASI ROPE CARRYING MECHANISM	2	
11	GK-35.01.07	FİTİL GASKET	12	