

MİMARİ KATALOG

ARCHITECTURAL CATALOGUE

Alüminyum Kapı Pencere ve Giydirme Cephe Sistemleri
Aluminium Door Window and Facade Systems

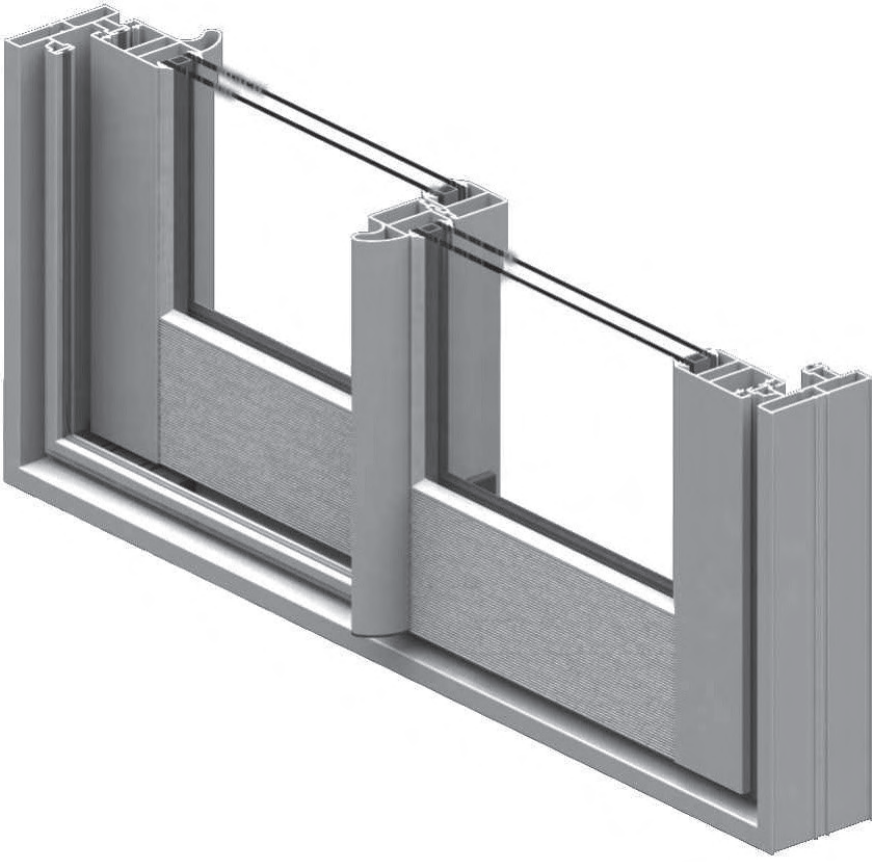

R583

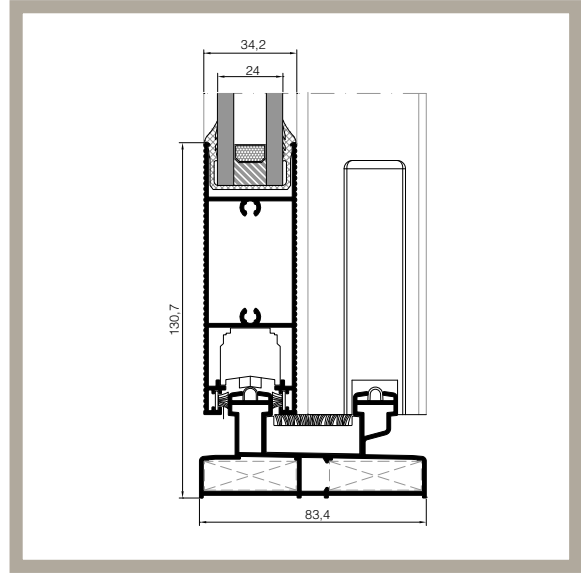
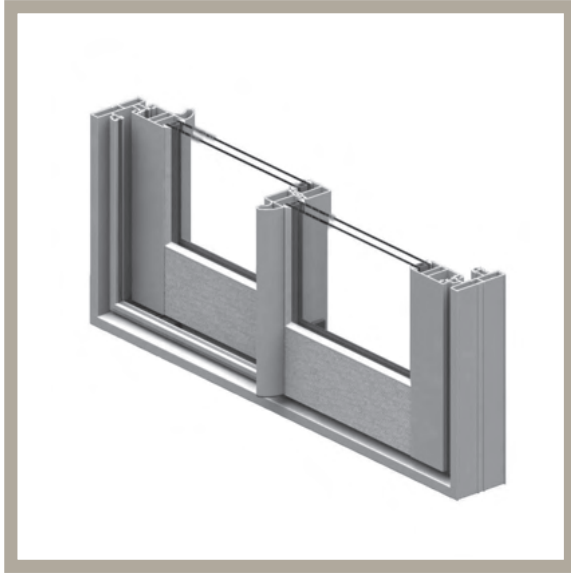

TEKNİK ÖZELLİKLER / TECHNICAL PROPERTIES

KASA DERİNLİĞİ / FRAME DEPTH	min.83,4mm - max.90,4mm
KANAT DERİNLİĞİ / VENT DEPTH	min.34,2mm - max.72,8mm
PROFİL ET KALINLIĞI / PROFILE WALL THICKNESS	1,4 mm
CAM KALINLIĞI / GLASS THICKNESS	8 / 10 / 24 mm

KULLANIM SEÇENEKLERİ / APPLICATION ALTERNATIVES

	KAPI DOOR	PENCERE WINDOW
BASİT SÜRME / SLIDING	•	•
90° KANAT BİRLEŞİMİ / 90° VENT COMBINATION	•	•
CAM ÇITASIZ KANAT / VENT WITHOUT GLAZING BEAD	•	•
SİNEKLİK / INSECT SCREEN	•	•

RÜZGAR YÜKÜNE GÖRE KULLANIM LİMİTLERİ GRAFİĞİ
USAGE DIAGRAM FOR THE WIND LOAD

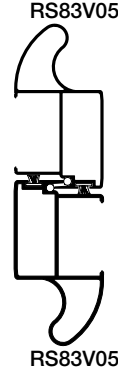
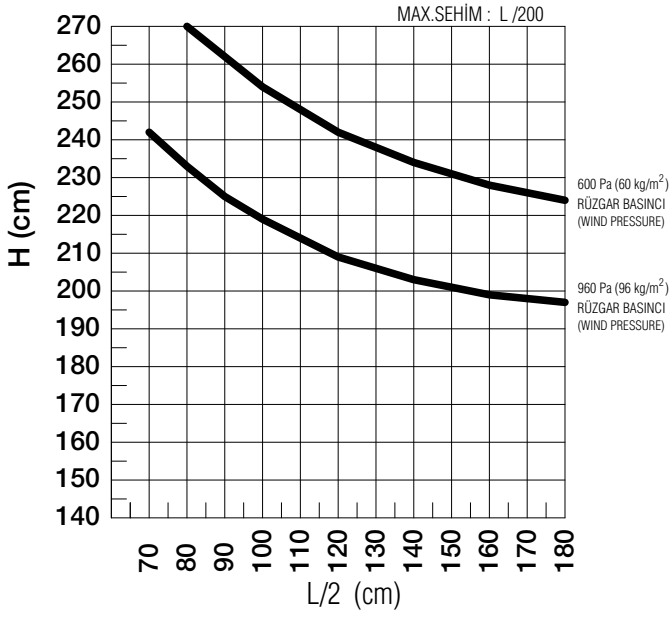

RS83V05 Jx: 17,252 cm⁴
RS83V05 Jx: 17,252 cm⁴
TOPLAM Jx: 34,504 cm⁴

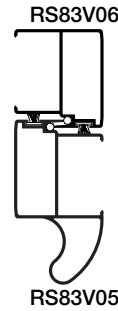
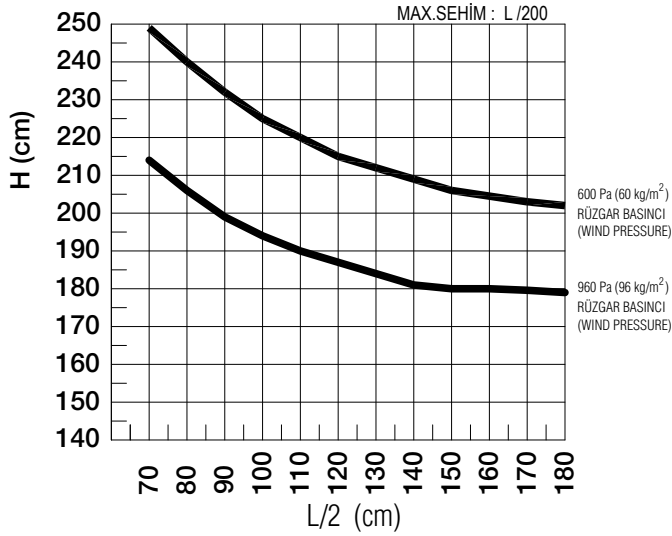
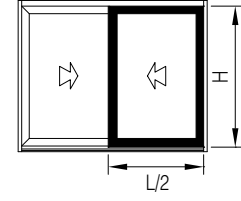

RS83V06 Jx: 6,384 cm⁴
RS83V05 Jx: 17,252 cm⁴
TOPLAM Jx: 23,636 cm⁴

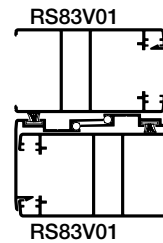
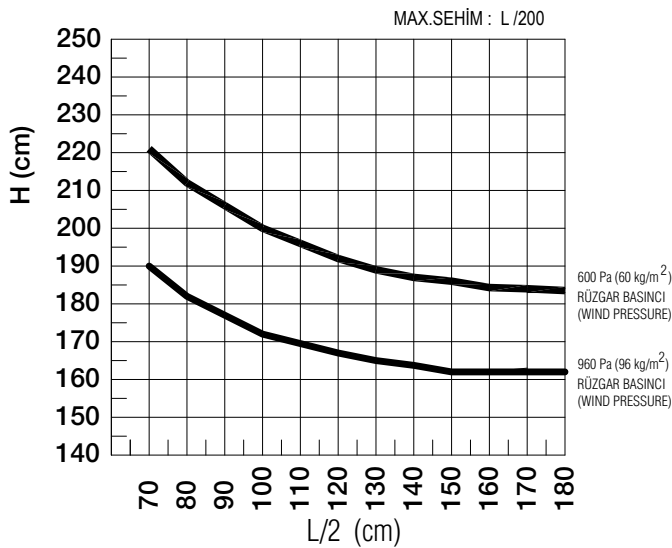

RS83V01 Jx: 8,141 cm⁴
RS83V01 Jx: 8,141 cm⁴
TOPLAM Jx: 16,282 cm⁴

01

02

03

04

05

06

SİSTEM TİPOLOJİSİ
SYSTEM TYPOLOGY

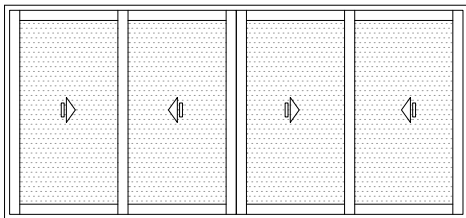
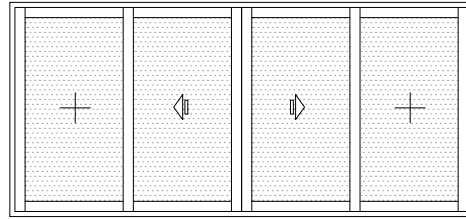
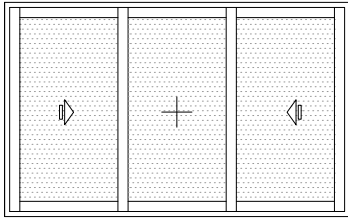
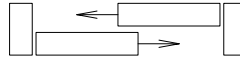
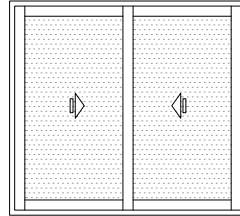
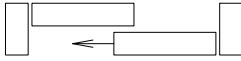
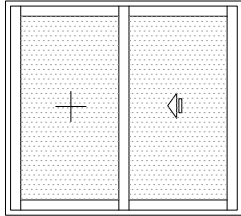

MİMARİ KATALOG

ARCHITECTURAL CATALOGUE

Alüminyum Kapı Pencere ve Giydirme Cephe Sistemleri
Aluminium Door Window and Facade Systems

RS83

PROFİLLER

PROFILES

KOD / CODE	AĞIRLIK (kg/m) / WEIGHT	Jxx cm ⁴	Jyy cm ⁴	L m	
RS83 F 01	1,373	7,823	30,747	6	
RS83 F 02	1,558	8,922	44,572	6	
RS83 F 03	----	----	----	6	

RS83 F 01

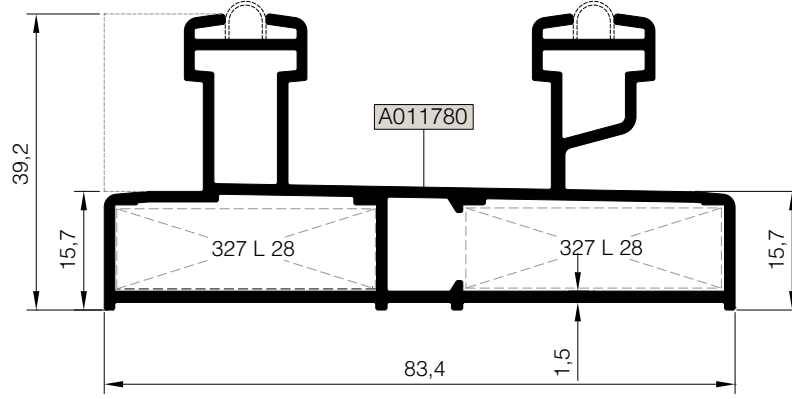

RS83 F 02

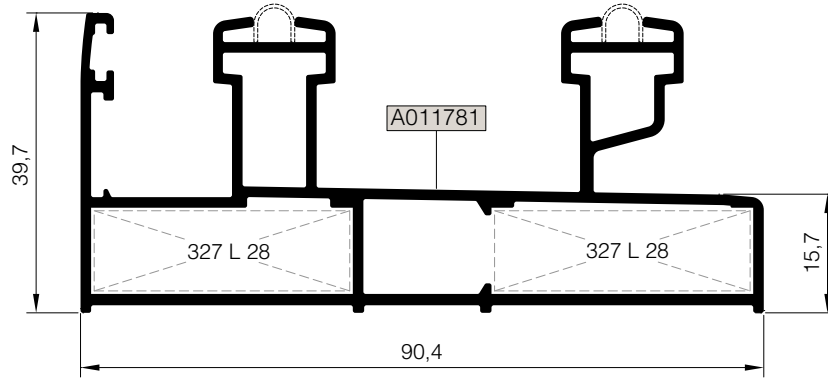

**RS83 F 03
Sineklik Kanadı için Kasa

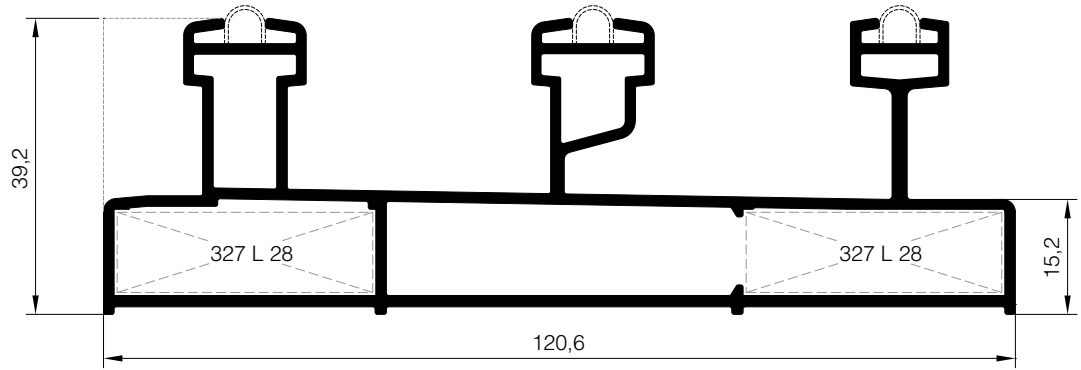

**Kalıp aktif değildir. Sipariş üzerine yapılacaktır.
The die is not active. It will be produced by order.

Nr		L m	KESİM ÖLÇÜSÜ CUTTING SIZE	AKS. KODU ACS. CODE
RS83 F 01	A011780	25 L 28 (A010542)	34,2 mm	327 L 28
RS83 F 02	A011781	25 L 28 (A010542)	34,2 mm	327 L 28

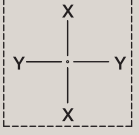
KOD / CODE	AĞIRLIK (kg/m) / WEIGHT	Jxx cm ⁴	Jyy cm ⁴	L m	
RS83 F 04	----	----	----	6	
RS83 F 05	----	----	----	6	

****RS83 F 04**

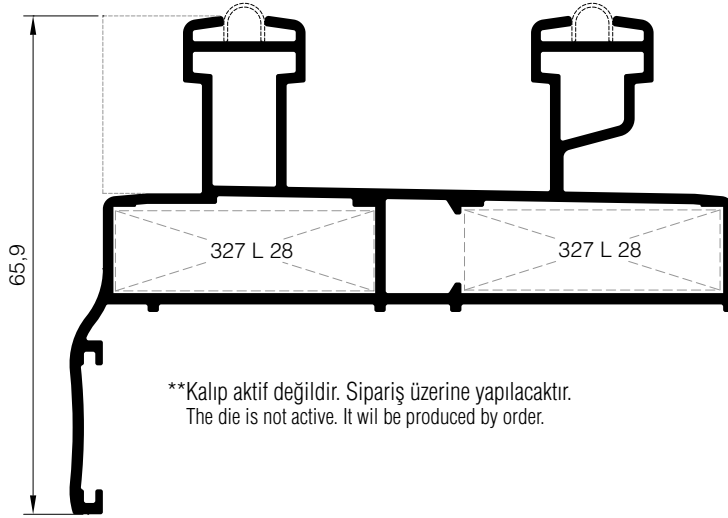

****RS83 F 05**

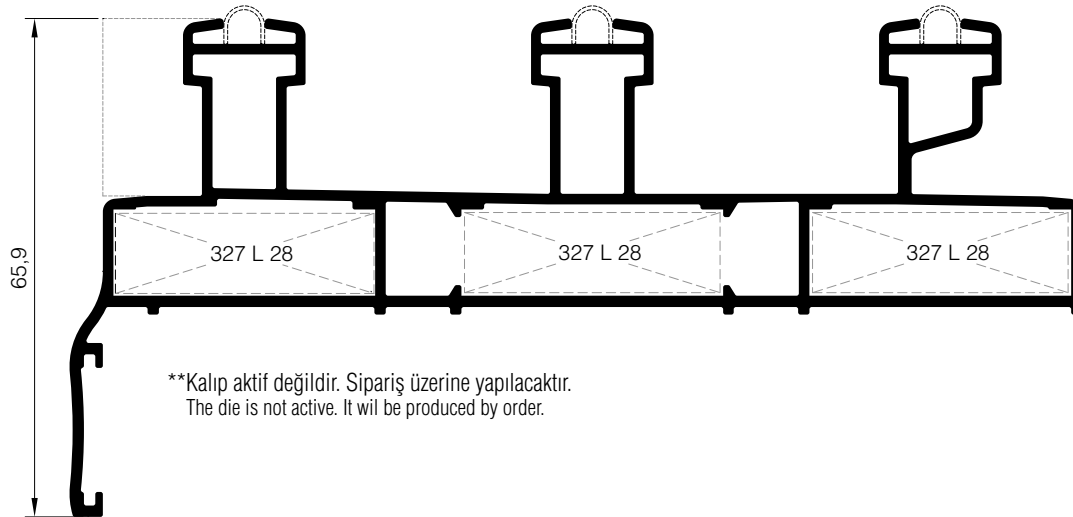

01



02

03

04

05

06

Nr		 L m	KESİM ÖLÇÜSÜ CUTTING SIZE	 AKS. KODU ACS. CODE
RS83 F 04	----	25 L 28 (A010542)	34,2 mm	327 L 28
RS83 F 05	----	25 L 28 (A010542)	34,2 mm	327 L 28

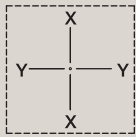
KOD / CODE	AĞIRLIK (kg/m) / WEIGHT	Jxx cm ⁴	Jyy cm ⁴	L m	
RS83 V 01	0,940	12,328	8,141	6	
RS83 V 02	1,216	16,884	18,027	6	
RS83 V 03	0,996	12,334	8,353	6	

RS83 V 01

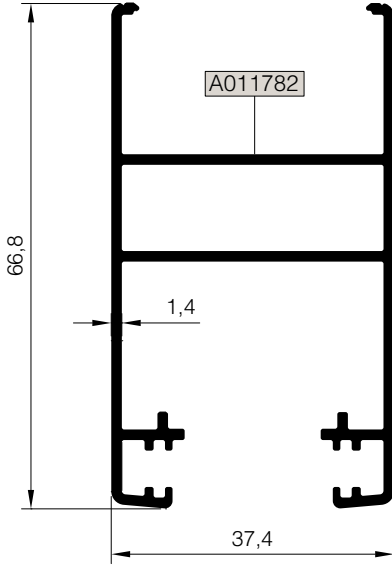

RS83 V 02

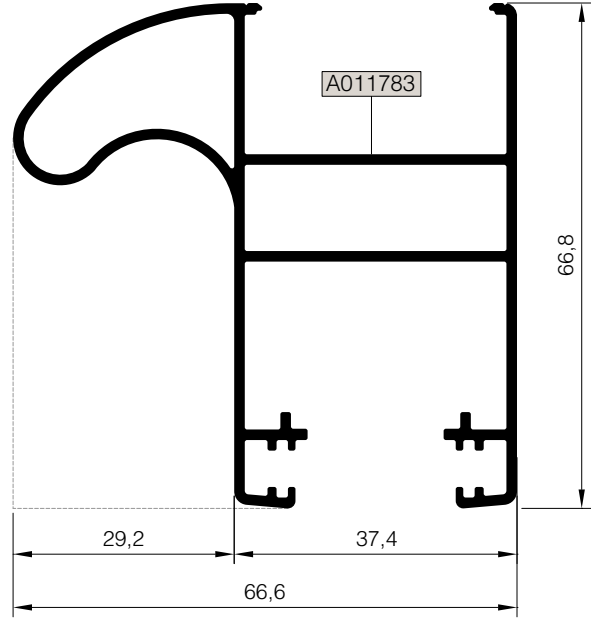

RS83 V 03

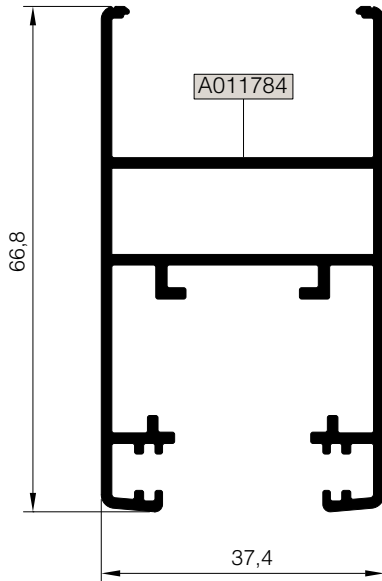

01

02

03

04

05

06

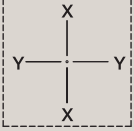
KOD / CODE	AĞIRLIK (kg/m) / WEIGHT	Jxx cm ⁴	Jyy cm ⁴	L m	
RS83 V 04	1,273	40,427	9,294	6	
RS83 V 05	0,937	4,748	17,252	6	
RS83 V 06	0,661	3,209	6,384	6	

RS83 V 04

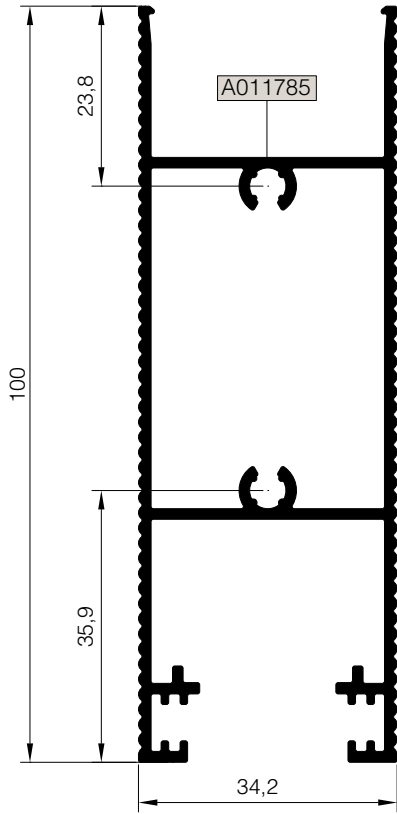

RS83 V 05

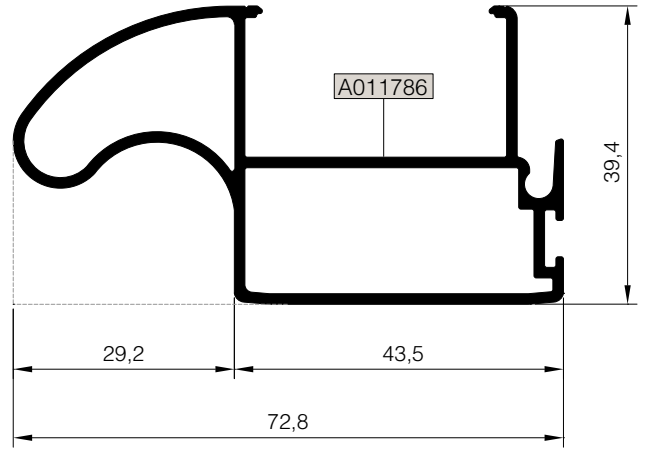

RS83 V 06

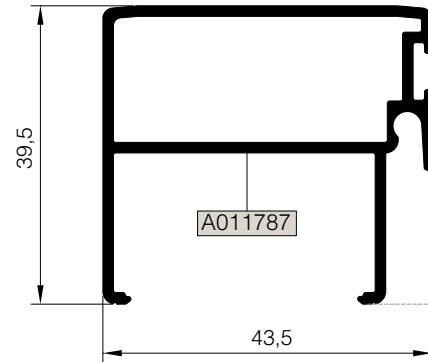

01

02

03

04

05

06

ADAPTÖR VE TİJ PROFİLLERİ

ADAPTER AND SLIDING ROD PROFILES

RS83

KOD / CODE	AĞIRLIK (kg/m) / WEIGHT	Jxx cm ⁴	Jyy cm ⁴	L m	
RS83 A 02	0,379	2,353	1,808	6	
RS83 A 03	0,254	0,428	0,872	6	
RS83 A 04	0,509	3,445	1,284	6	
TS58 V 06	0,917	4,270	10,506	6	
25 I 07	0,143	---	---	6	

RS83 A 02

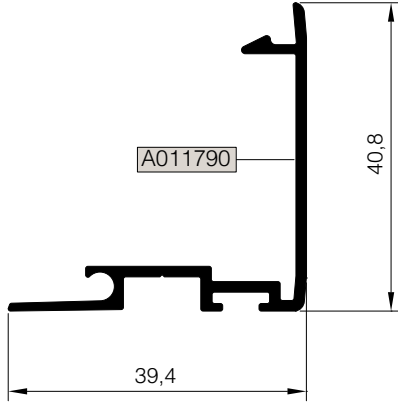

RS83 A 03

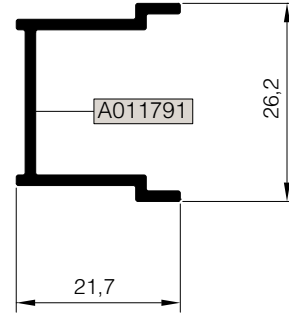

RS83 A 04

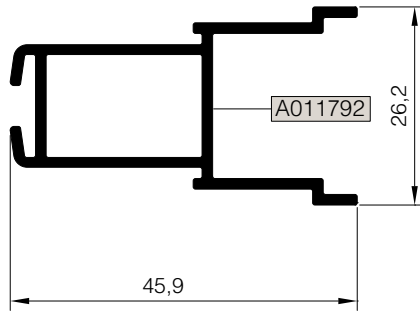

TS58 V 06

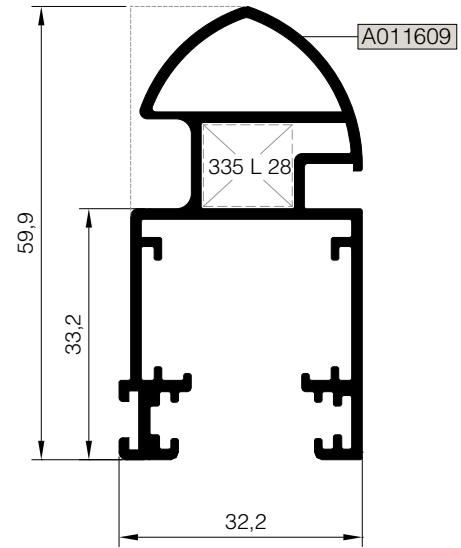

25 I 07

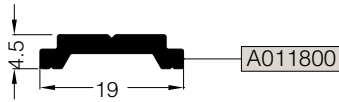

STOKTA BULUNAN SİSTEM PROFİLLERİNİN LİSTESİ / (LIST OF SYSTEM PROFILES IN STOCK)

Nr	MIN. SİPARİŞ MİKTARI MIN. ORDER QUANTITY
RS83 F 01	A011780 75 kg
RS83 F 04	A011785 75 kg
RS83 V 01	A011782 75 kg
RS83 V 05	A011786 75 kg
RS83 V 06	A011787 75 kg

* STOKTA BULUNMAYAN TÜM PROFİLLER İÇİN MİNİMUM SİPARİŞ MİKTARI 300 KG'DİR.
MINIMUM ORDER QUANTITY FOR ALL THE PROFILES THAT ARE NOT IN STOCK IS 300 KG.

MİMARİ KATALOG

ARCHITECTURAL CATALOGUE

Alüminyum Kapı Pencere ve Giydirme Cephe Sistemleri
Aluminium Door Window and Facade Systems

RS83

DETAYLAR

DETAILS

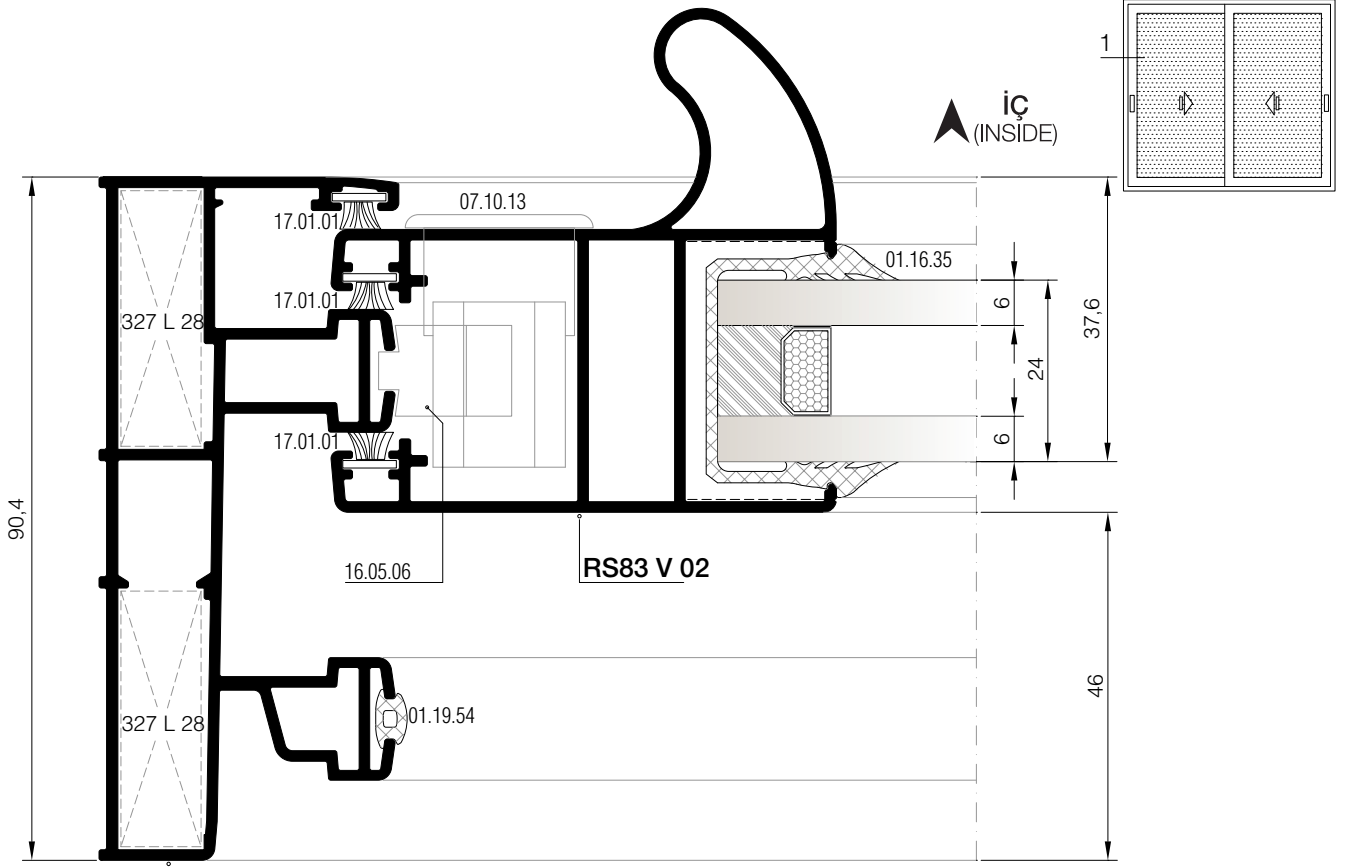

RS83 F 02

1 DETAYI
DETAIL

iç
(INSIDE)

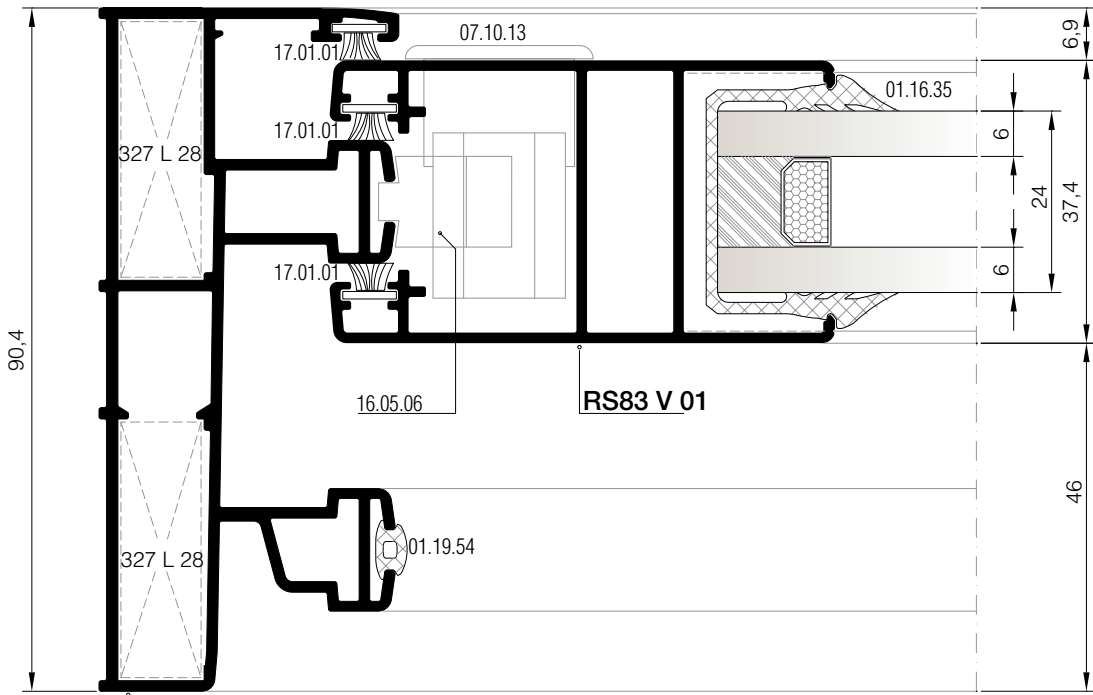

RS83 F 02

1A DETAYI
DETAIL

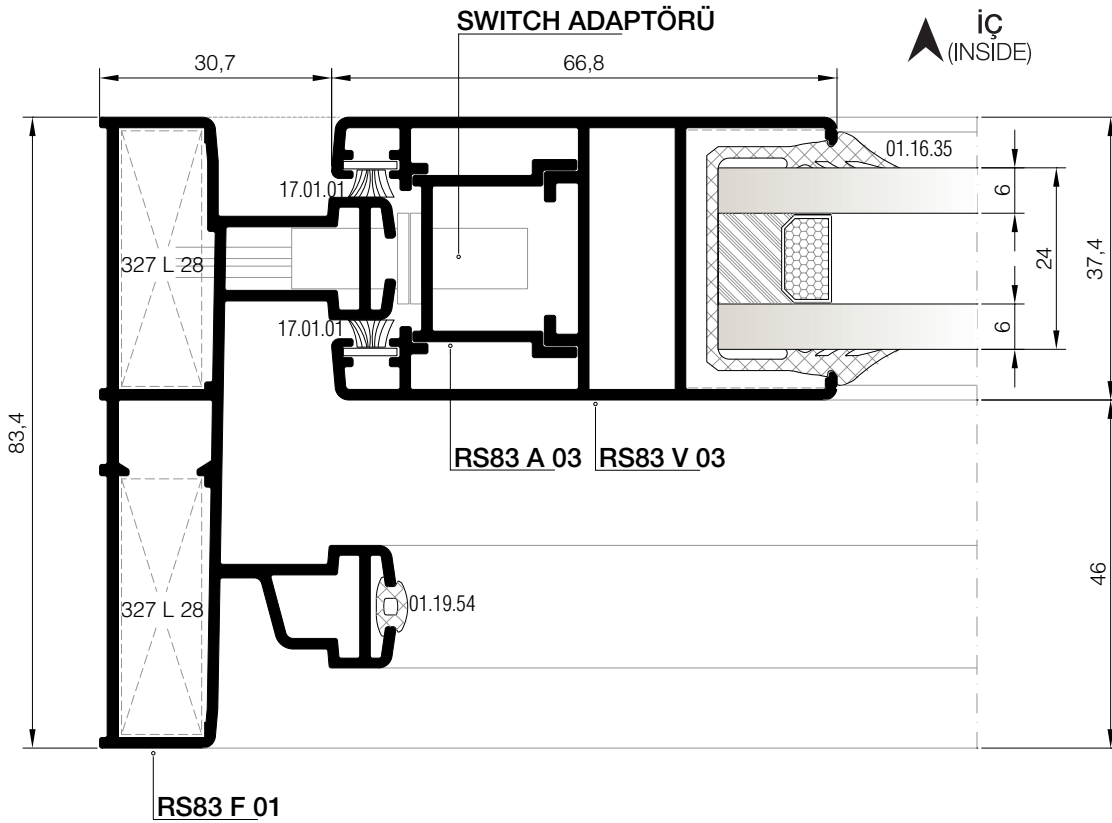
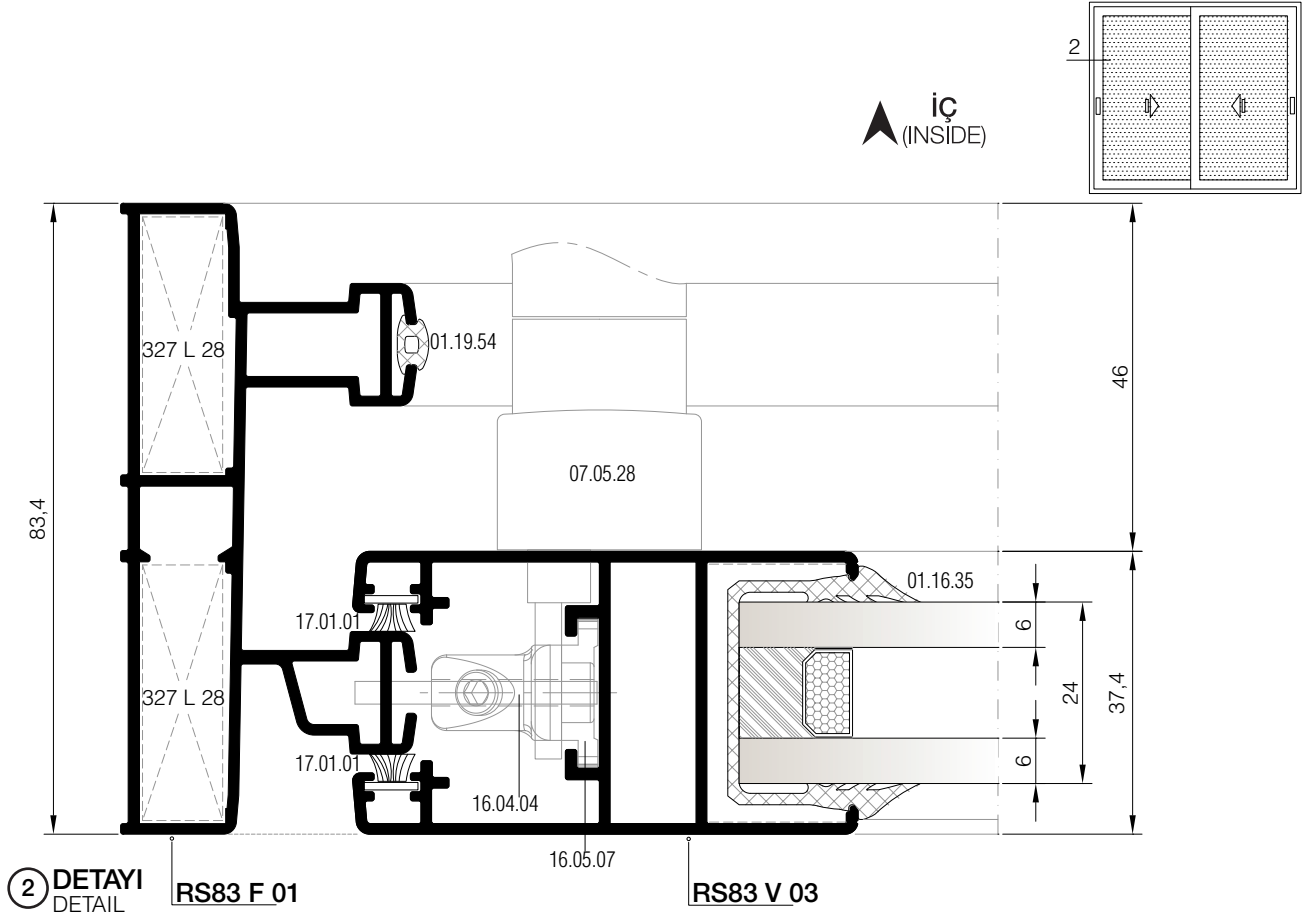

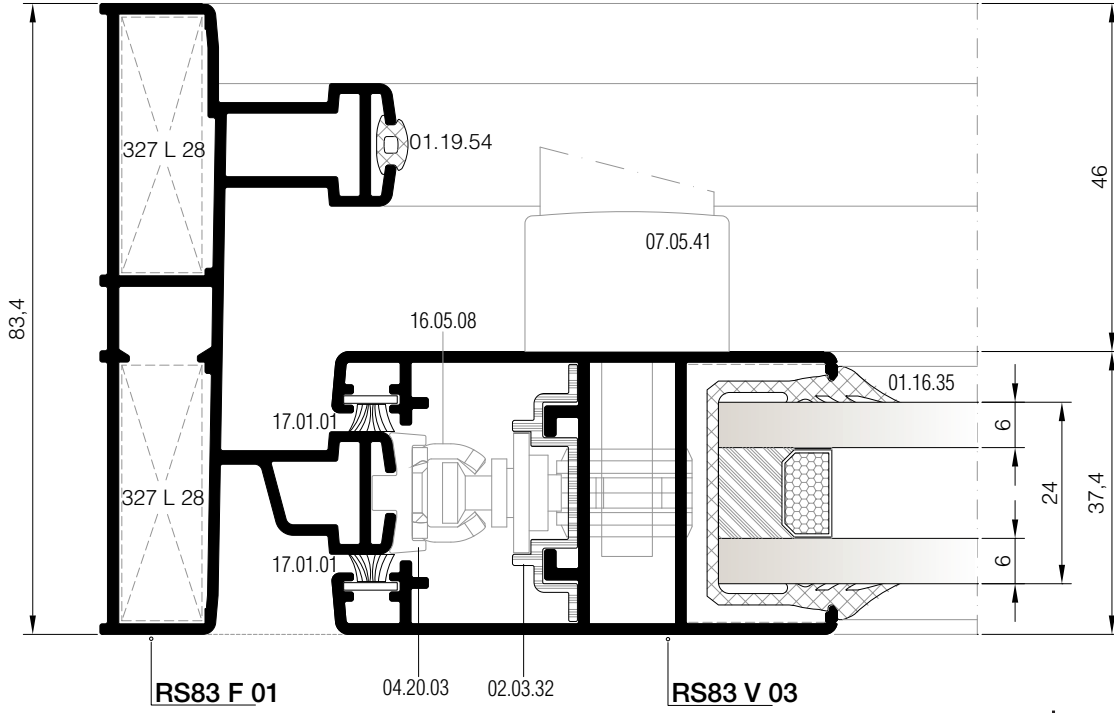
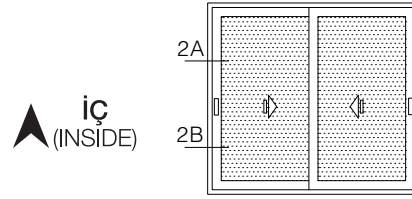

2A DETAYI
DETAIL

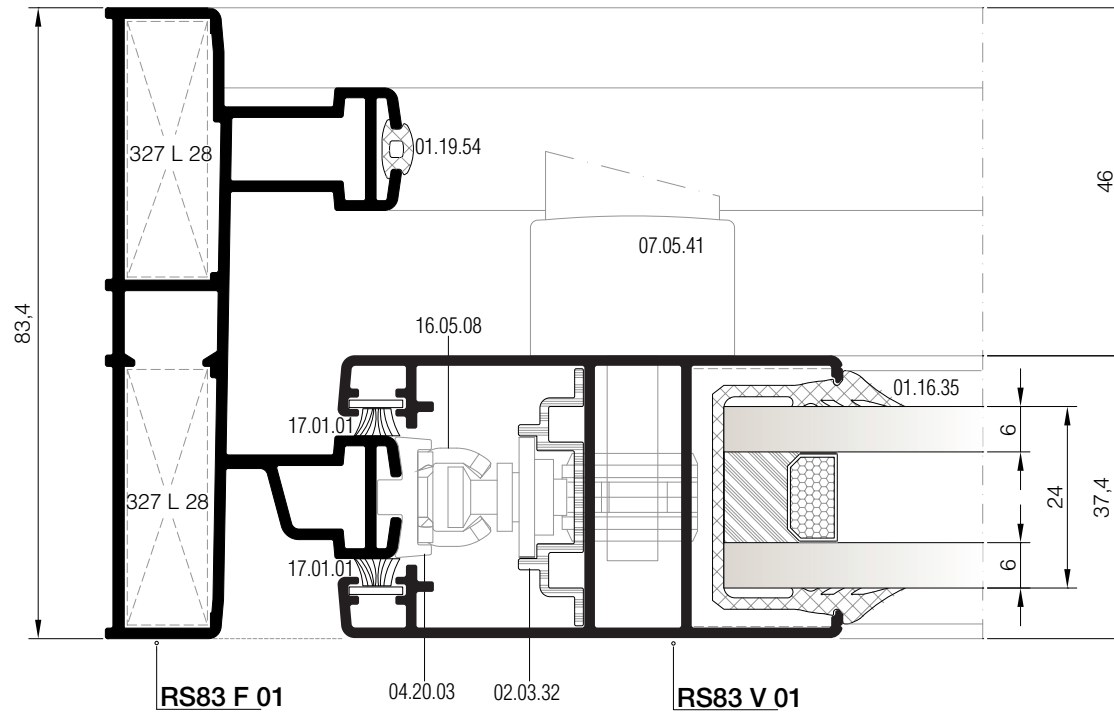

2B DETAYI
DETAIL

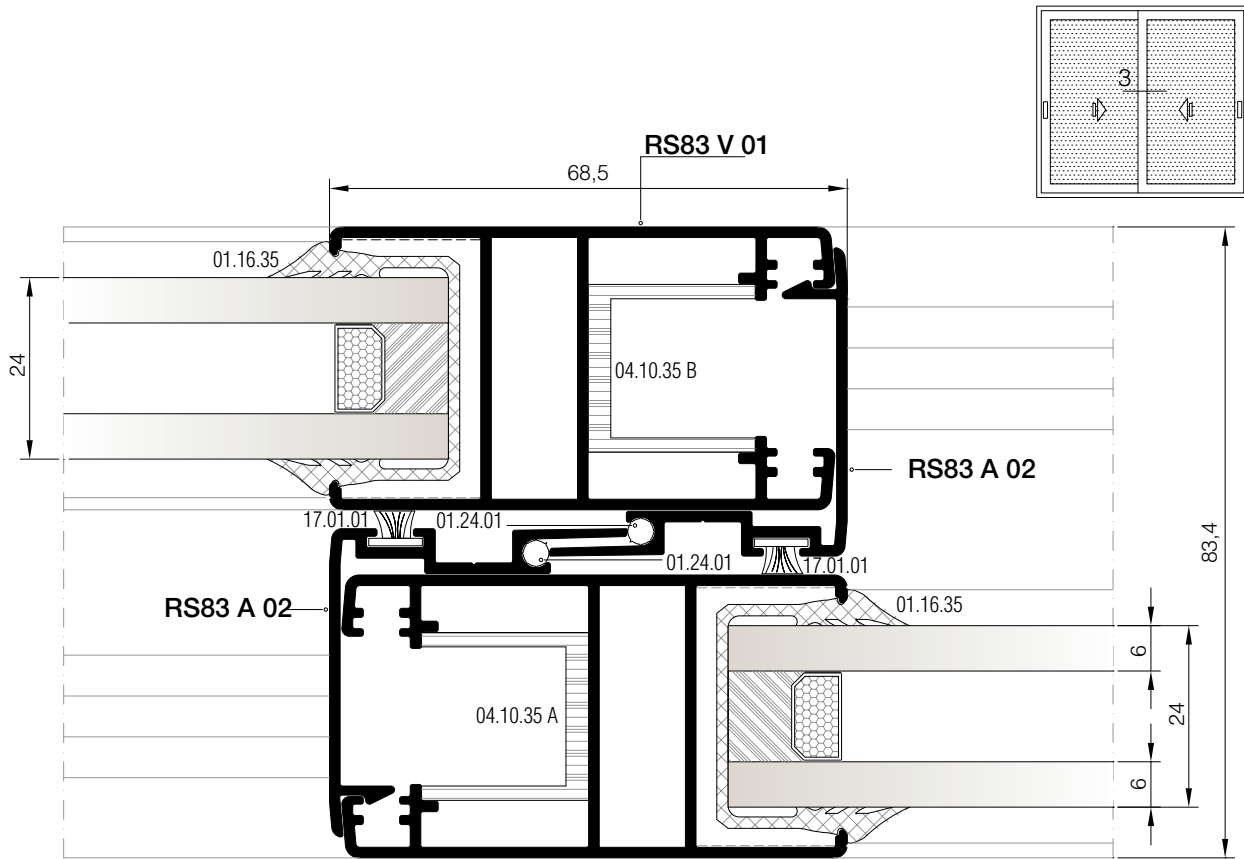

③ DETAYI
DETAIL

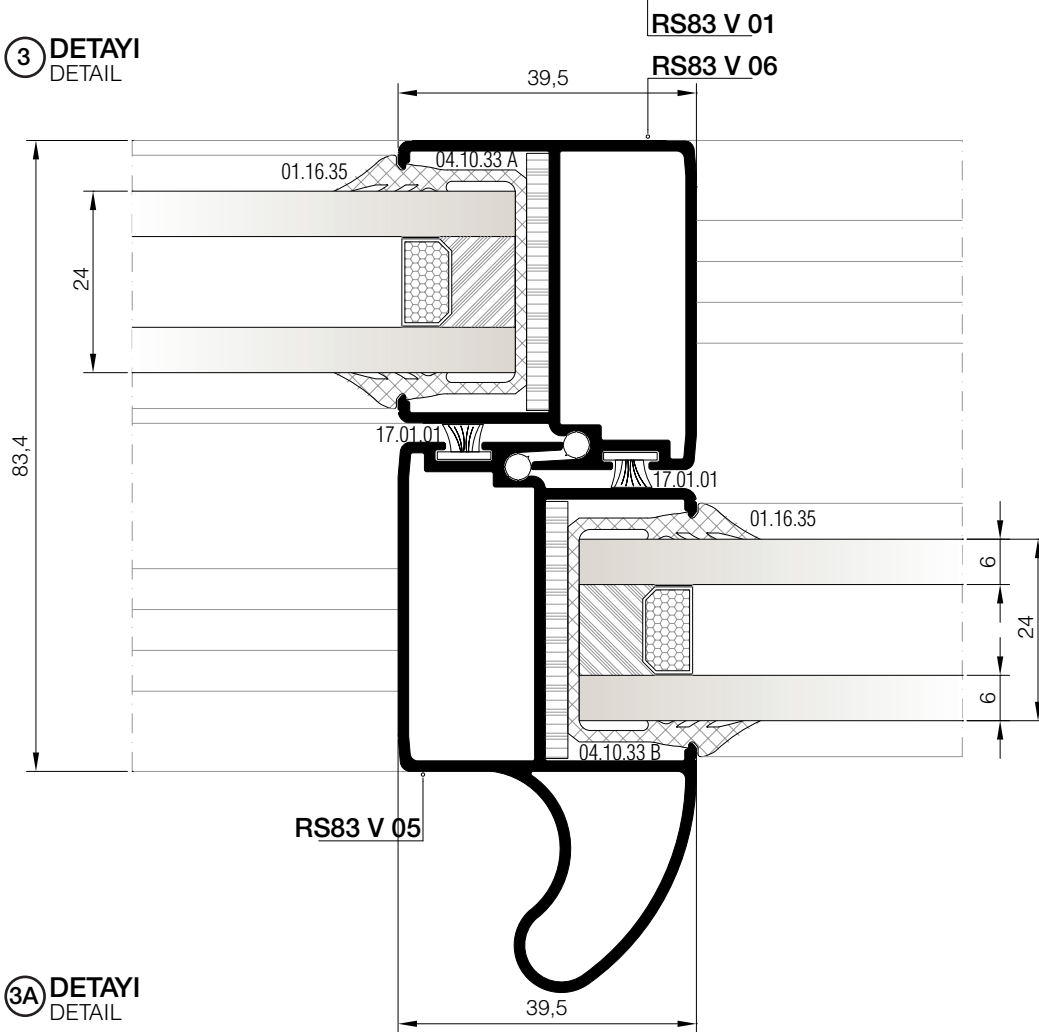

③A DETAYI
DETAIL

01

02

03

04

05

06

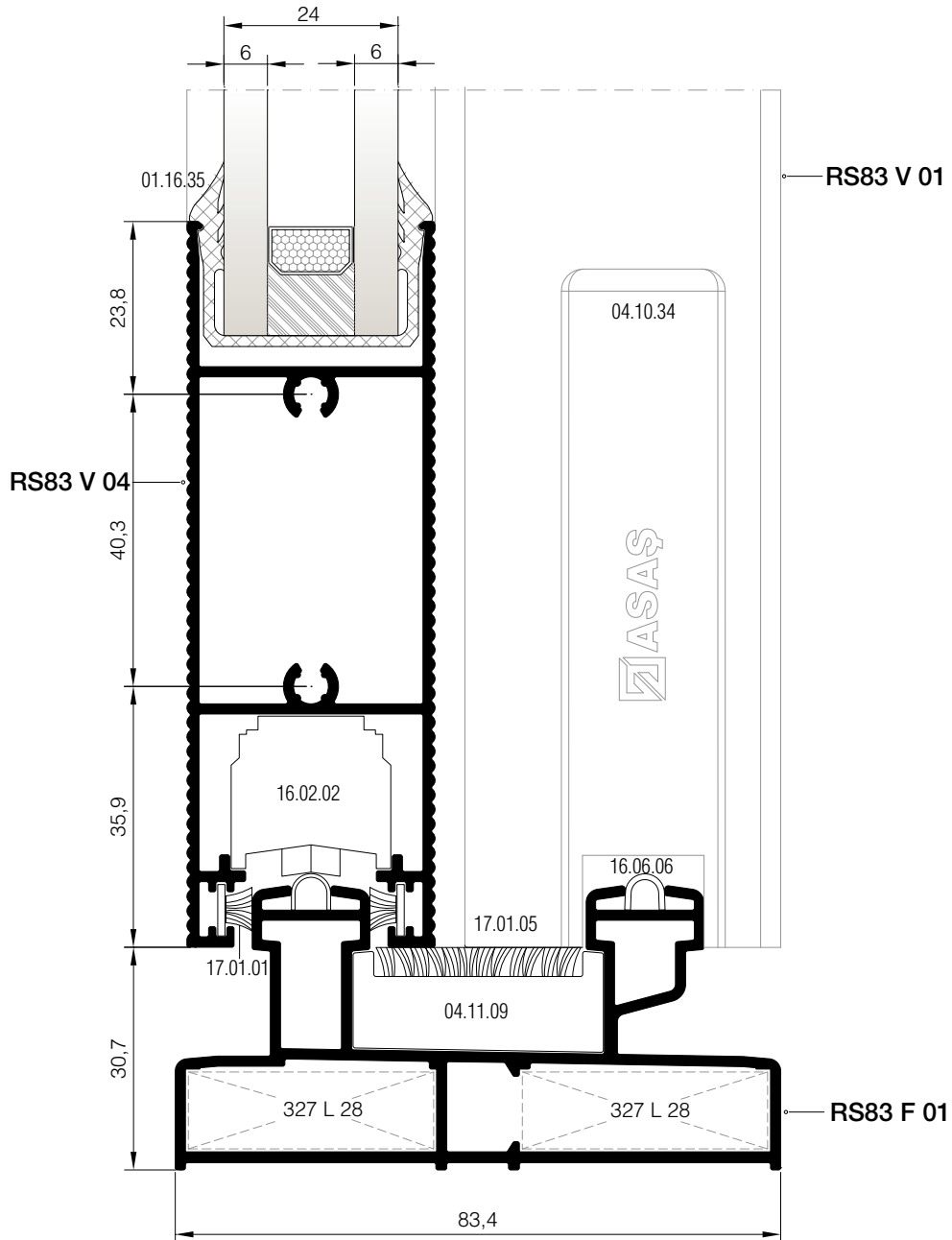
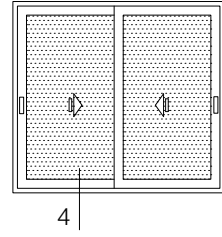

- 01
- 02
- 03
- 04
- 05
- 06

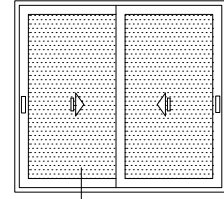

4A

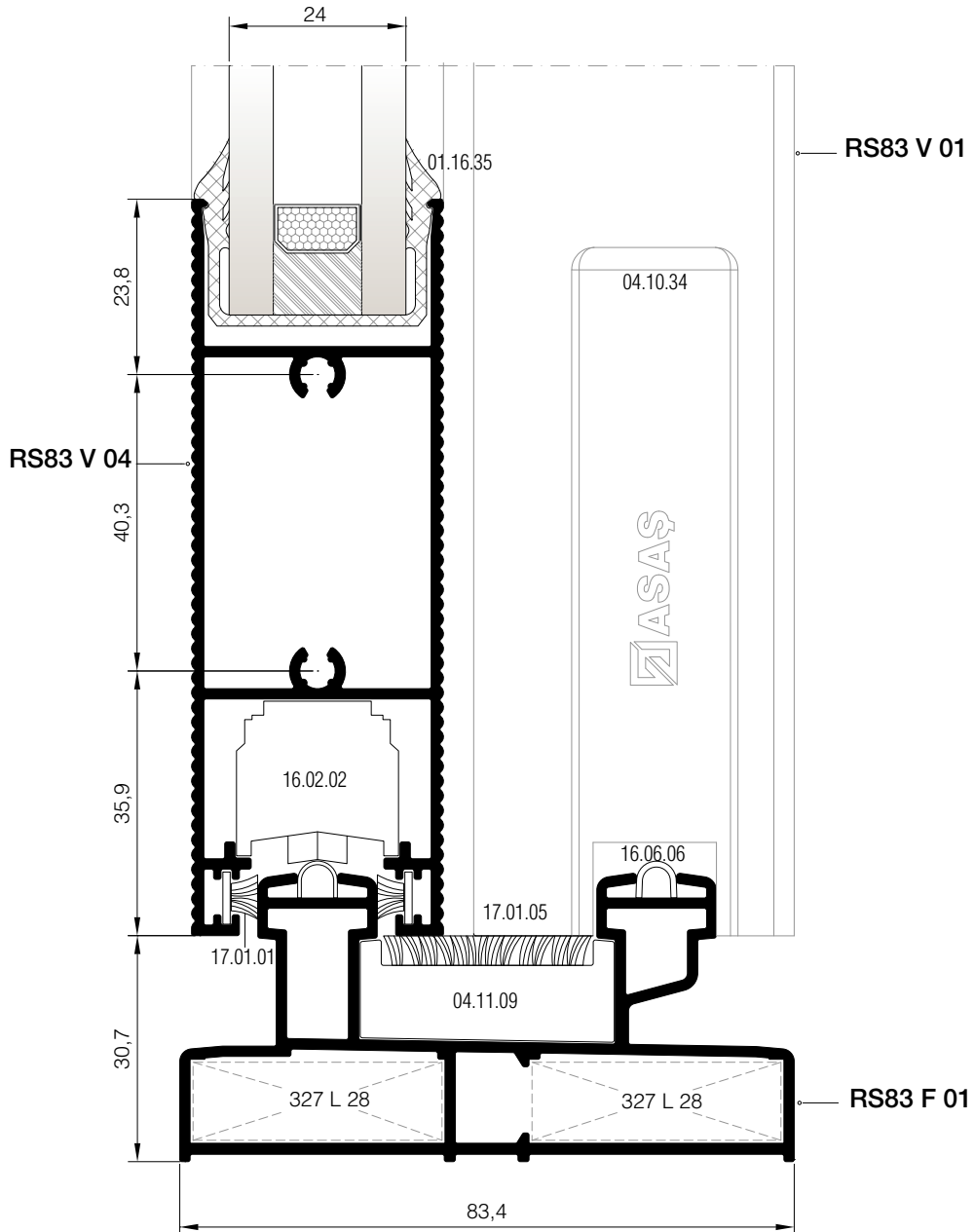

01

02

03

04

05

06

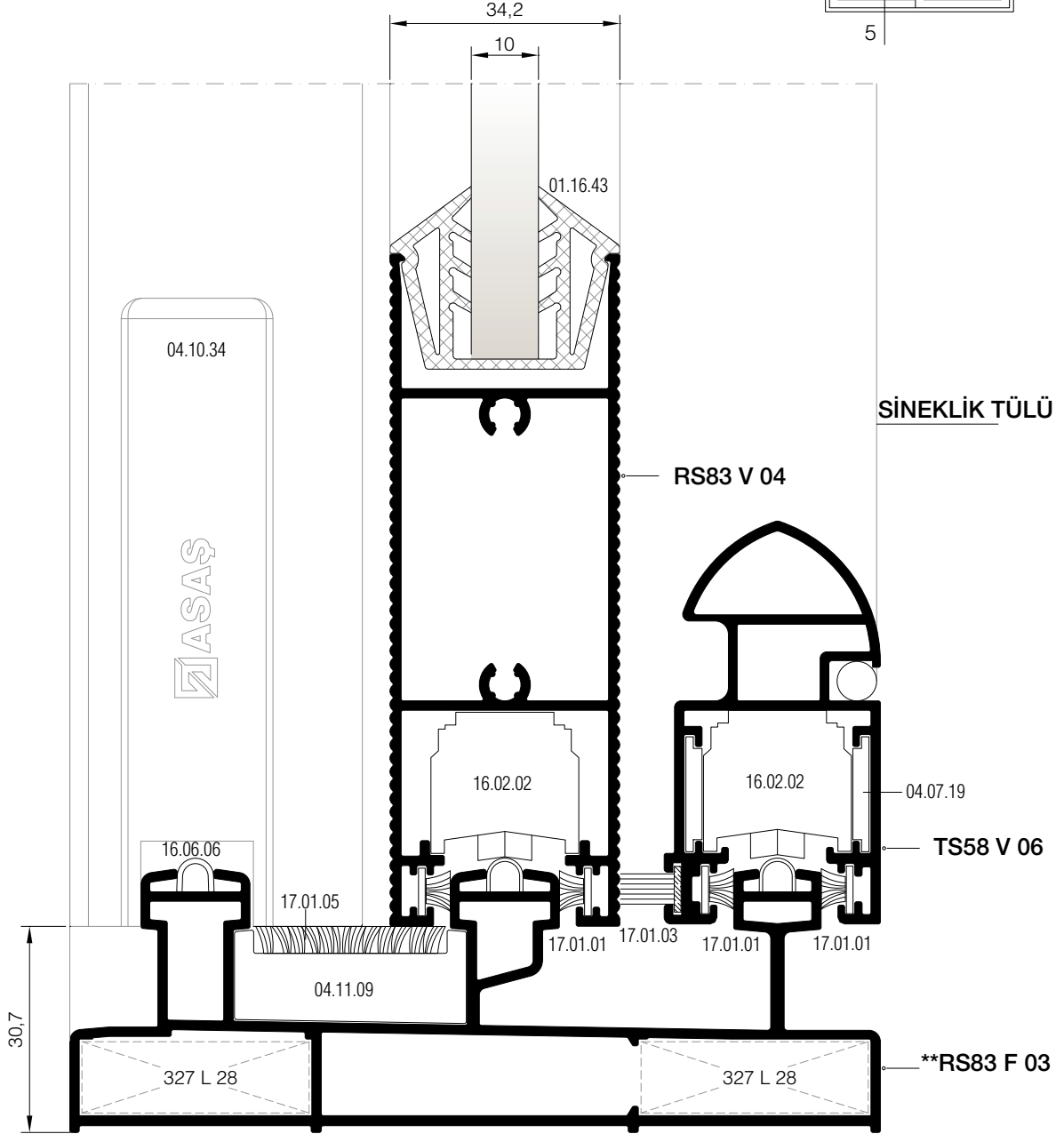
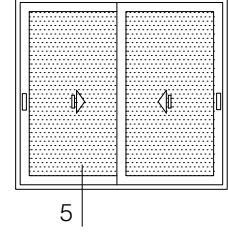

**Kalıp aktif değildir. Sipariş üzerine yapılacaktır.
The die is not active. It will be produced by order.

DIŞ
(OUTSIDE) ➔

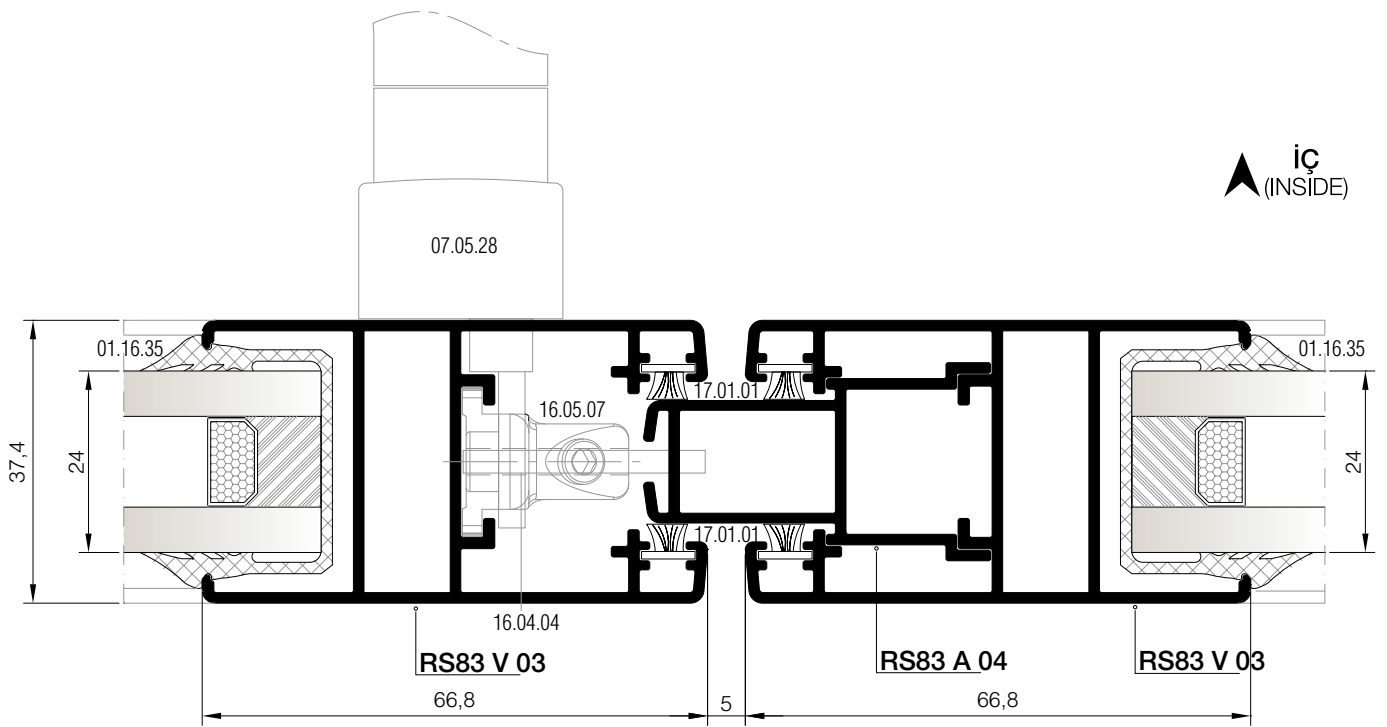
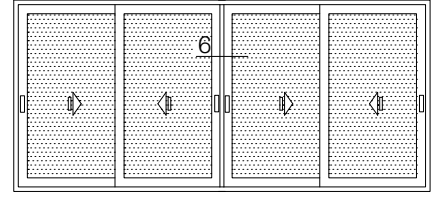

MİMARİ KATALOG











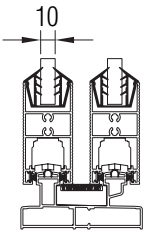

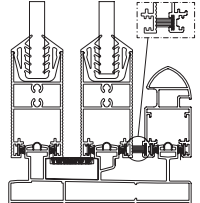

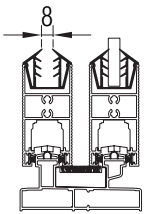

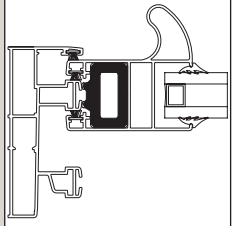
ARCHITECTURAL CATALOGUE

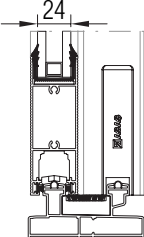

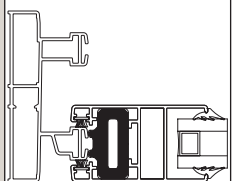

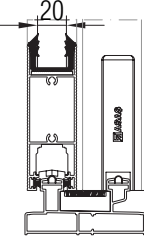

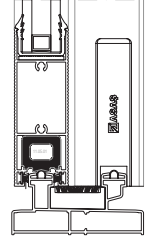
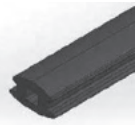

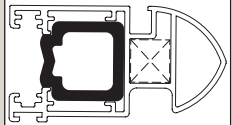
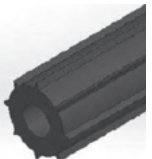
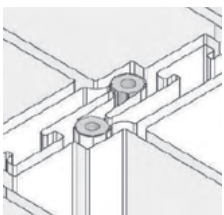
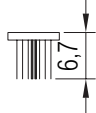
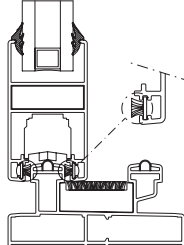

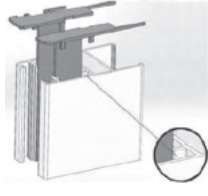

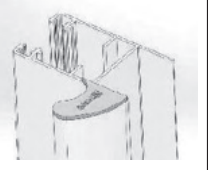

Alüminyum Kapı Pencere ve Giydirme Cephe Sistemleri
Aluminium Door Window and Facade Systems

RS83

AKSESUARLAR

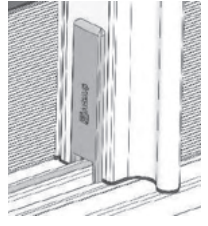
ACCESSORIES

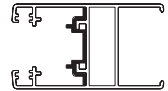
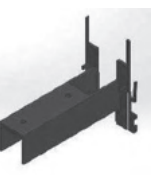
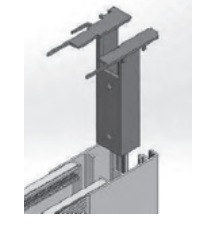
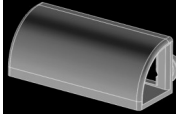
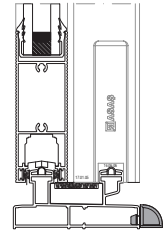
	 <p>01.16.43 CAM FİTİLİ GLAZING GASKET</p> <p>Malzeme / Material: EPDM Ağırlık / Weight: 445 gr/m Paket / Package: 39 m / 15 kg</p>		 <p>17.01.03 KIL FİTİL BRUSH</p> <p>Paket / Package: 200 mt</p>	
01	 <p>01.16.44 CAM FİTİLİ GLAZING GASKET</p> <p>Malzeme / Material: EPDM Ağırlık / Weight: 509 gr/m Paket / Package: 30 m / 15 kg</p>		 <p>19.01.12 STOPER STOPPER</p> <p>Malzeme / Material: EPDM</p>	
02	 <p>01.16.35 DIŞ CAM FİTİLİ GLAZING GASKET</p> <p>Malzeme / Material : EPDM Ağırlık / Weight : 240 gr/m Paket / Package : 62 m / 15 kg</p>		 <p>19.01.13 STOPER STOPPER</p> <p>Malzeme / Material: EPDM</p>	
03	 <p>01.16.36 CAM FİTİLİ GLAZING GASKET</p> <p>Malzeme / Material: EPDM Ağırlık / Weight: 310 gr/m Paket / Package: 48 m / 15 kg</p>		 <p>11.05.01 KANAT SABİTLEME TAKOZU VENT FIXING PART</p> <p>Malzeme / Material: PVC</p>	
04	 <p>01.19.54 CAM FİTİLİ GLAZING GASKET</p> <p>Malzeme / Material: EPDM Ağırlık / Weight: 28 gr/m Paket / Package: 530 m / 15 kg</p>		 <p>19.01.10 STOPER STOP</p> <p>Malzeme / Material: EPDM (TS58 V 06 için / for TS58 V 06)</p>	
05	 <p>01.24.01 MT-216 A KENET FİTİLİ CONNECTION GASKET</p> <p>Malzeme / Material: EPDM Ağırlık / Weight: 10 gr/m Paket / Package: 1500 m / 15 kg</p>			
06	 <p>17.01.01 KIL FİTİL 670X700 BRUSH 670X700</p> <p>Malzeme / Material: Polipropilen / Polipropilene Paket / Package: 275 mt</p>			

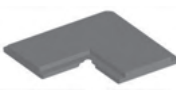
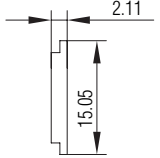
	<p>04.10.32 A PVC KAPAK (SOL) PVC CAP (LEFT) Malzeme / Material: PVC RS83 V 03 İÇİN / FOR RS83 V 03</p>			<p>04.10.36 A PVC KAPAK (SAĞ) PVC CAP (RIGHT) Malzeme / Material: PVC RS83 V 02-RS83 V 05 İÇİN FOR RS83 V 02-RS83 V 05</p>	
	<p>04.10.32 B PVC KAPAK (SAĞ) PVC CAP (RIGHT) Malzeme / Material: PVC RS83 V 03 İÇİN / FOR RS83 V 03</p>			<p>04.10.36 B PVC KAPAK (SOL) PVC CAP (LEFT) Malzeme / Material: PVC RS83 V 02 / RS83 V 05 İÇİN FOR RS83 V 02 / RS83 V 05</p>	
	<p>04.10.33 A PVC KAPAK (SOL) PVC CAP (LEFT) Malzeme / Material: PVC RS83 V 05-RS83 V 06 İÇİN FOR RS83 V 05-RS83 V 06</p>			<p>04.11.09 ALT-ÜST SEVİYE TAKOZU LOWER-TOP SUPPORT LEVEL Malzeme / Material: PVC</p>	
	<p>04.10.33 B PVC KAPAK (SAĞ) PVC CAP (RIGHT) Malzeme / Material: PVC RS83 V 05-RS83 V 06 İÇİN FOR RS83 V 05-RS83 V 06</p>			<p>02.03.18 SİNEKLİK ADAPTÖRÜ INSECT SCREEN ADAPTER Malzeme / Material: PVC</p>	
	<p>04.10.34 PVC KAPAK PVC CAP Malzeme / Material: PVC</p>			<p>02.03.32 SÜRME KANAT İSPANYOLET ADAPTÖRÜ SLIDING VENT HANDLE ADAPTER Malzeme / Material: PVC</p>	
	<p>04.10.35 A PVC KAPAK PVC CAP Malzeme / Material: PVC RS83 V 01-RS83 V 02 İÇİN FOR RS83 V 01-RS83 V 02</p>			<p>04.02.09 TAHLİYE KAPAĞI DRAINAGE COVER Malzeme / Material: PVC</p>	
	<p>04.10.35 B PVC KAPAK (SAĞ) PVC CAP (RIGHT) Malzeme / Material: PVC RS83 V 01-RS83 V 02 İÇİN FOR RS83 V 01-RS83 V 02</p>			<p>04.07.19 KÖŞE ÇAVUŞU CORNER CLEAT Malzeme / Material: PVC</p>	

01

02

03

04

05

06

 <p>07.05.28 RESCARA GLOBAL PENCERE KOLU (TEK DİLLİ) RESCARA GLOBAL HANDLE FOR WINDOWS (SINGLE RAIL) Renk / Colour: Siyah-Beyaz-Gri Black-White-Grey</p> <p>EN 1670</p>	 <p>07.05.25 GIESSE İSPANYOLET KOL (ÇİFT DİLLİ) GIESSE HANDLE FOR WINDOWS (DOUBLE RAIL) Renk / Colour: Siyah-Beyaz-Gri Black-White-Grey</p> <p>UNI CEI EN ISO / IEC 17050</p>
 <p>07.05.32 RESCARA GLOBAL PENCERE KOLU (ÇİFT DİLLİ) RESCARA GLOBAL HANDLE FOR WINDOWS (DOUBLE RAIL) Renk / Colour: Siyah-Beyaz-Gri Black-White-Grey</p> <p>EN 1670, 13126-8</p>	 <p>07.25.01 GIESSE TIJ BAĞLANTI PARÇASI GIESSE CONNECTION ROD Malzeme / Material: Polyamid / Polyamide Renk / Colour: Siyah-Black</p> <p>07.05.25 Kol için / For Handle 07.05.25</p>
 <p>07.13.08 RESCARA KOL BAĞLANTI PARÇASI RESCARA CONNECTION PART FOR HANDLE Malzeme / Material: PVC</p> <p>07.05.32 Kol için / For Handle 07.05.32</p>	 <p>07.13.07 KOL BAĞLANTI PARÇASI CONNECTION PART FOR HANDLE Malzeme / Material: Zamak -Zamak</p> <p>07.05.28 Kol için / For Handles 07.05.28</p>
 <p>16.05.07 KİLİT ADAPTÖRÜ LOCK ADAPTER</p> <p>07.05.25, 07.05.28 ve 07.05.32 Kolları için / For Handles 07.05.25, 07.05.28 and 07.05.32</p>	 <p>16.05.02 SÜRME KİLİT KARŞILIĞI STRIKER FOR SLIDING LOCK</p> <p>07.05.25, 07.05.28 ve 07.05.32 Kolları için / For Handles 07.05.25, 07.05.28 and 07.05.32</p>
 <p>16.04.04 SÜRME DİL SLIDING BOLT</p> <p>07.05.25, 07.05.28 ve 07.05.32 Kolları için / For Handles 07.05.25, 07.05.28 and 07.05.32</p>	

KOL İLE KİLİTLEME SEÇİM TABLOSU
LOCKING KIT SELECTION TABLE WITH HANDLE

KOD CODE	TANIM DESCRIPTION	ADET NUMBER				KANAT VENT	
		H: 0-1200 mm	H: 1201-1799 mm	H: 1800-2199mm	H: 2200-2500 mm		
RESCARA TEK DİLLİ KOL RESCARA SINGLE RAIL HANDLE	07.05.28	RESCARA GLOBAL PENCERE KOLU RESCARA GLOBAL HANDLE	1	1	1	1	RS83 V 03
	07.13.07	KOL BAĞLANTI PARÇASI CONNECTION PART FOR HANDLE	1	1	1	1	
GIESSE ÇİFT DİLLİ KOL GIESSE DOUBLE RAIL HANDLE	07.05.25	GIESSE İSPANYOLET KOL GIESSE HANDLE FOR WINDOWS	1	1	1	1	
	07.25.01	GIESSE TIJ BAĞLANTI PARÇASI GIESSE CONNECTION ROD	1	1	1	1	
RESCARA ÇİFT DİLLİ KOL RESCARA DOUBLE RAIL HANDLE	07.05.32	RESCARA GLOBAL PENCERE KOLU RESCARA GLOBAL HANDLE	1	1	1	1	
	07.13.08	RESCARA KOL BAĞLANTI PARÇASI RESCARA CONNECTION ROD	1	1	1	1	
16.05.07	KİLİT ADAPTÖRÜ LOCK ADAPTER	2	3	4	5		
16.04.04	SÜRME DİL SLIDING BOLT	2	3	4	5		
16.05.02	SÜRME KİLİT KARŞILIĞI STRIKER FOR SLIDING LOCK	2	3	4	5		

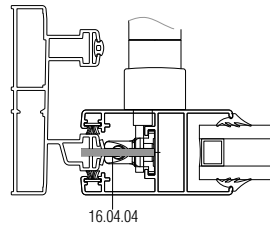
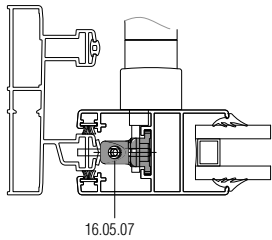
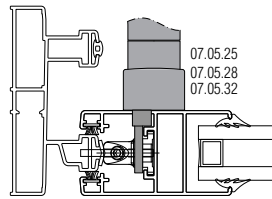

01

02

03

04

05

06



07.10.12

HAVUZLU KİLİT ANAHTARLI
SLIDING LOCK WITH KEY

Malzeme / Material: Alüminyum- Zamak
Aluminium -Zamak



07.10.13

HAVUZLU KİLİT
SLIDING LOCK

Malzeme / Material: Alüminyum- Zamak
Aluminium -Zamak



07.10.14

ÇİFTLİ HAVUZLU KİLİT ANAHTARLI
DOUBLE SLIDING LOCK WITH KEY

Malzeme / Material: Alüminyum- Zamak
Aluminium -Zamak



07.10.09

HAVUZ KOL
SLIDING HANDLE

Malzeme / Material: Alüminyum- Zamak
Aluminium -Zamak

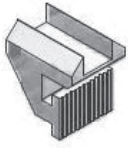

07.11.03

KOL ÜSTÜ KARŞILIK
STRIKER FOR HANDLE

07.10.12 , 07.10.13 , 07.10.14 Sürme Kilit için / For Handle 07.10.12 , 07.10.13 , 07.10.14



16.05.06

SÜRME KİLİT KARŞILIĞI
STRIKER FOR SLIDING LOCK

07.10.12 , 07.10.13 , 07.10.14 Sürme Kilit için / For Handle 07.10.12 , 07.10.13 , 07.10.14

01

02

03

04

05

06

HAVUZLU KOL İLE KİLİTLEME SEÇİM TABLOSU

LOCKING KIT SELECTION TABLE WITH SLIDING LOCK

KOD CODE	TANIM DESCRIPTION	ADET NUMBER	KANAT VENT
07.10.12 07.10.13 07.10.14	HAVUZLU KİLİT SLIDING LOCK	1	RS83 V 01 RS83 V 02
16.05.06	SÜRME KİLİT KARŞILIĞI STRIKER FOR SLIDING LOCK	1	
07.11.03	KOL ÜSTÜ KARŞILIK STRIKER FOR HANDLE	1	

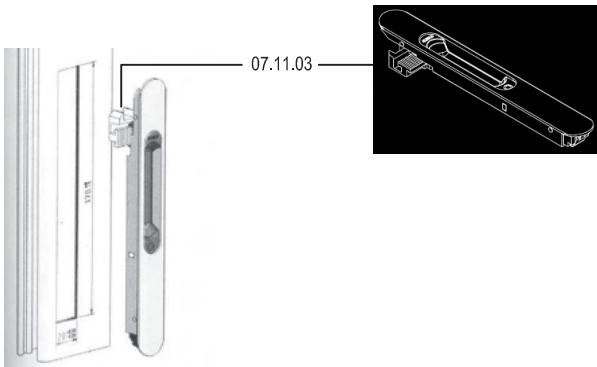
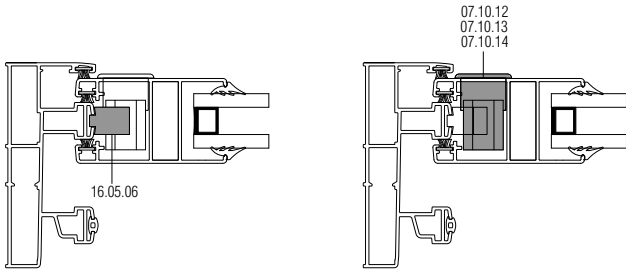

01

02

03

04

05

06



07.05.41

RESCARA AKUSTİK PENCERE KOLU
RESCARA ACOUSTIC HANDLE

Renk / Colour: Siyah-Beyaz-Gri
Black-White-Grey



07.05.42

RESCARA AKUSTİK PENCERE KOLU
RESCARA ACOUSTIC HANDLE

Renk / Colour: Siyah-Beyaz-Gri
Black-White-Grey



07.05.48

RESCARA GİZLİ SÜRME KOLU
RESCARA HIDDEN SLIDING HANDLE

Renk / Colour: Siyah-Beyaz-Gri
Black-White-Grey

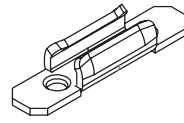

16.05.08

SÜRME KİLİT KARŞILIĞI
STRIKER FOR SLIDING LOCK

07.05.41, 07.05.42, 07.05.48 PVC Kol için / For PVC Handle 07.05.41, 07.05.42, 07.05.48

07.18.XX

15 EKSEN SÜRME İSPANYOLETİ I
15 AXIS STEEL GEARBOX SLIDING ESPOGNOLETTE

Renk / Colour: Siyah-Beyaz-Gri
Black-White-Grey

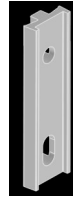

04.20.03

SÜRME KİLİT KARŞILIĞI ALT PLASTİK PARÇASI
TIN PLATE STRIKER FOR SLIDING LOCK

Malzeme / Material : PVC

07.18.xx 15 EKSEN SÜRME İSPANYOLETİ
07.18.xx 15 AXIS STEEL GEARBOX SLIDING ESPOGNOLETTE

KOD CODE	ÖLÇÜ DIMENSION
07.18.32	h: 600mm-800 mm / 15
07.18.33	h:800mm-1000mm / 15
07.18.34	h: 1000mm-1200mm / 15
07.18.35	h: 1200mm-1400mm / 15
07.18.36	h: 1400mm-1600mm / 15
07.18.37	h:1600mm-1800mm / 15
07.18.38	h:1800mm-2000mm / 15
07.18.39	h:2000mm-2100mm / 15

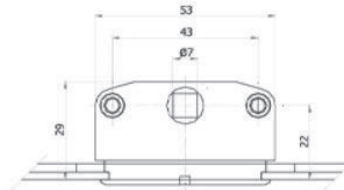

PVC KOL İLE KİLİTLEME SEÇİM TABLOSU
LOCKING KIT SELECTION TABLE WITH PVC HANDLE

KOD CODE	TANIM DESCRIPTION	ADET NUMBER	KANAT VENT
07.05.41 07.05.42 07.05.48	PVC İSPANYOLET KOL PVC HANDLE	1	RS83 V 01 RS83 V 03
16.05.08	SÜRME KİLİT KARŞILIĞI STRIKER FOR SLIDING LOCK	BKZ.07.18.xx SEÇİM TABLOSU SEE 07.18.xx SELECTION TABLE	
04.20.03	SÜRME SAC KARŞILIĞI TIN PLATE STRIKER FOR SLIDING LOCK	BKZ. 07.18.xx SEÇİM TABLOSU SEE 07.18.xx SELECTION TABLE	
07.18.XX	SÜRME İSPANYOLETİ SLIDING ESPOGNOLETTE	1	

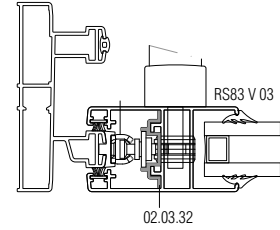
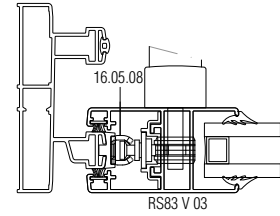
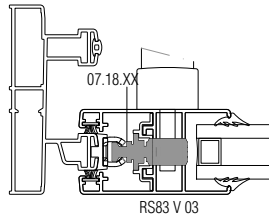
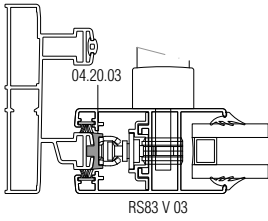
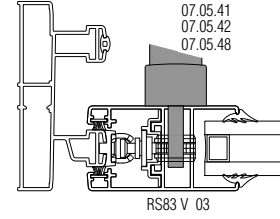

07.18.xx 15 EKSEN SÜRME İSPANYOLETİ
07.18.xx 15 AXIS STEEL GEARBOX SLIDING ESPOGNOLETTE

KOD CODE	TANIM DESCRIPTION	16.05.08 ADET/NUMBER	04.20.03 ADET/NUMBER
07.18.32	h: 600mm-800mm / 15	2	2
07.18.33	h:800mm-1000mm / 15	2	2
07.18.34	h: 1000mm-1200mm / 15	3	3
07.18.35	h: 1200mm-1400mm / 15	3	3
07.18.36	h: 1400mm-1600mm / 15	3	3
07.18.37	h:1600mm-1800mm / 15	3	3
07.18.38	h:1800mm-2000mm / 15	4	4
07.18.39	h: 2000mm-2100mm / 15	4	4

01

02

03

04

05

06

	 <p>16.02.02 GIESSE AYARLI ÇİFTLİ RULMAN GIESSE ADJUSTABLE CARRERA 2 PULLEYS</p> <p>Malzeme / Material: Alüminyum- Zamak Aluminium -Zamak</p> <hr/> <p>2 Adet 180 kg taşır. / 180 kg with 2 pulleys EN 13126-15 : 2008</p>	 <p>16.02.07 RESCARA AYARLI ÇİFTLİ RULMAN RESCARA ADJUSTABLE CARRERA 2 PULLEYS</p> <hr/> <p>2 Adet 120 kg taşır. / 120 kg with 2 pulleys</p>
01	 <p>16.01.01 AYARLI TEKLİ RULMAN PULLEY WITH SINGLE WHEEL</p> <p>Malzeme / Material: Alüminyum- Zamak Aluminium -Zamak</p> <hr/> <p>2 Adet 35 kg taşır. / 35 kg with 2 pulleys Max. kanat ölçüsü 600x1500./ Max. vent dimension 600x1500</p>	 <p>16.01.02 AYARLI ÇİFTLİ RULMAN ADJUSTABLE PULLEY</p> <p>Malzeme / Material: Alüminyum- Zamak Aluminium -Zamak</p> <hr/> <p>2 Adet 65 kg taşır. / 65 kg with 2 pulleys Max. kanat ölçüsü 1000x2100./ Max. vent dimension 1000x2100</p>
02		
03	 <p>16.01.12 METAL TEKERLEKLİ AYARLI RULMAN STEEL ADJUSTABLE PULLEYS</p> <hr/> <p>2 Adet 65 kg taşır. / 65 kg with 2 pulleys Max. kanat ölçüsü 1000x2100./ Max. vent dimension 1000x2100</p>	 <p>16.01.13 METAL TEKERLEKLİ AYARLI RULMAN PULLEY WITH SINGLE WHEEL</p> <hr/> <p>2 Adet 35 kg taşır. / 35 kg with 2 pulleys Max. kanat ölçüsü 600x1500./ Max. vent dimension 600x1500</p>
04		
05	 <p>16.02.06 SİNEKLİK RULMANI PULLEY FOR INSECT SCREEN</p> <hr/> <p></p>	 <p>16.06.06 ÇELİK RAY STEEL RAIL</p> <p>Malzeme / Material: Paslanmaz Çelik Stainless Steel</p> <hr/> <p></p>
06	 <p>21.01.08 PUNCH MAKİNESİ PUNCH MACHINE</p> <p>Pnömatik</p> <hr/> <p></p>	