

MİMARİ KATALOG ARCHITECTURAL CATALOGUE

Alüminyum Kapı Pencere ve Giydirme Cephe Sistemleri
Aluminium Window Doors and Facade Systems



RGK35

MİMARİ KATALOG

ARCHITECTURAL CATALOGUE

Alüminyum Kapı Pencere ve Giydirme Cephe Sistemleri
Aluminium Window Doors and Facade Systems

RGK35

PROFİLLER

PROFILES

01

02

03

04

05

06

07

08

09

10

11

KOD / CODE	AĞIRLIK (kg/m) / WEIGHT	L m
GK35 B 01	3,587	6
GK35 B 03	0,761	6

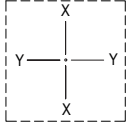

GK35 B 03

GK35 B 01

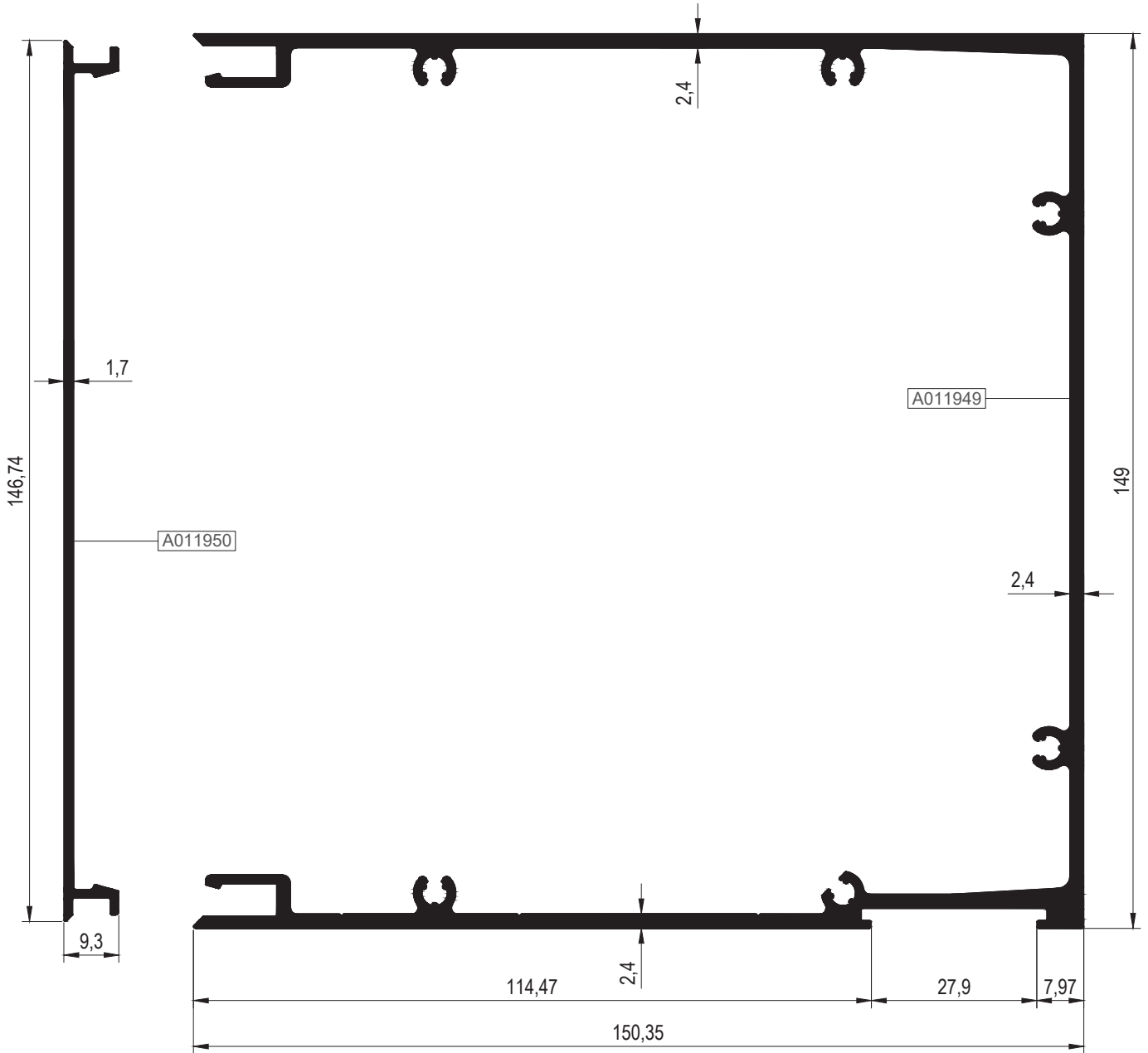

KOD / CODE	AĞIRLIK (kg/m) / WEIGHT	L m
GK35 F 01	3,469	6
GK35 F 02	2,066	6

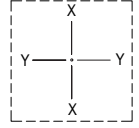

GK35 F 01

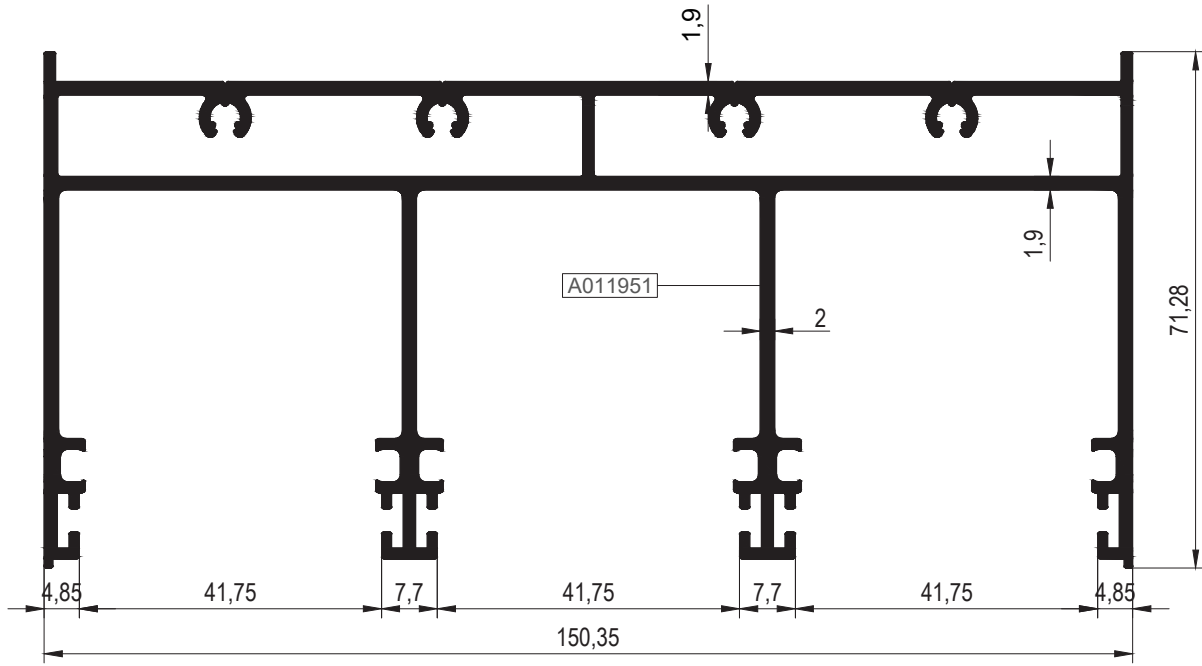

GK35 F 02

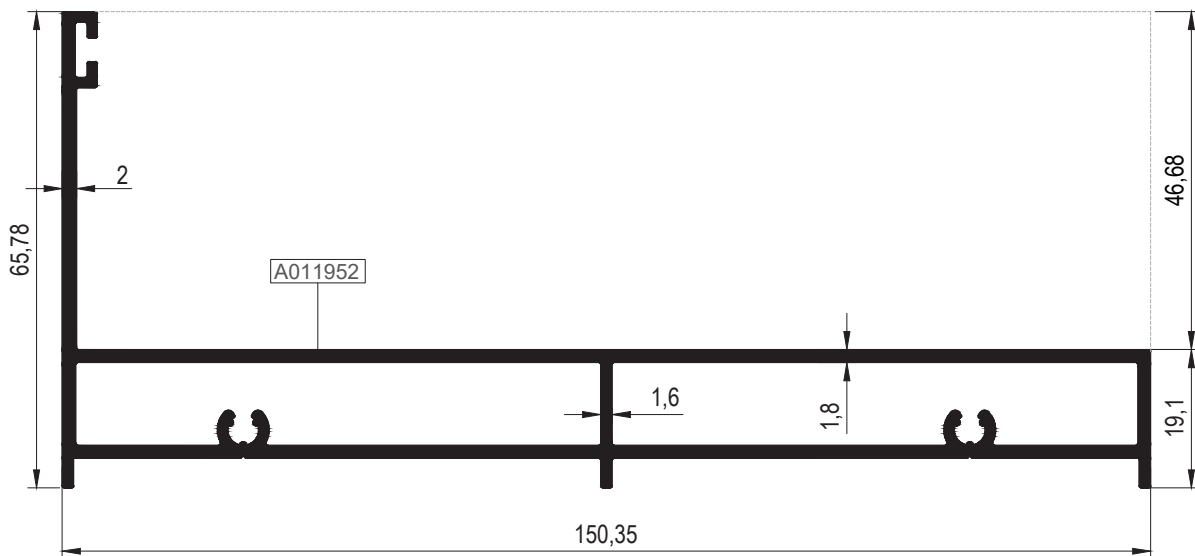

KOD / CODE	AĞIRLIK (kg/m) / WEIGHT	L m
GK35 A 01	1,233	6
GK35 V 01	1,071	6
GK35 G 01	0,149	6
GK35 A 02	0,821	6
GK35 A 03	0,192	6

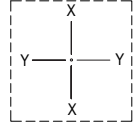

GK35 A 01

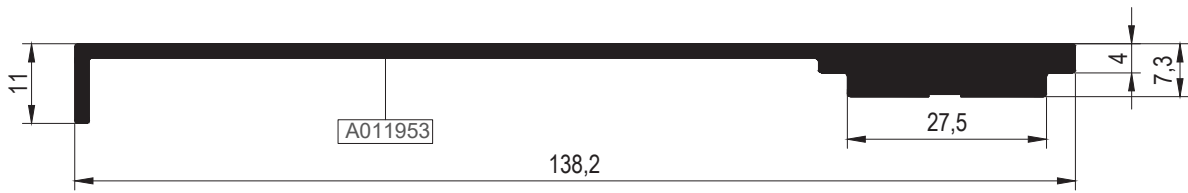

GK35 V 01

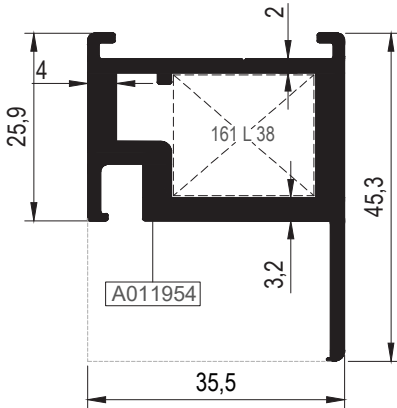

GK35 G 01

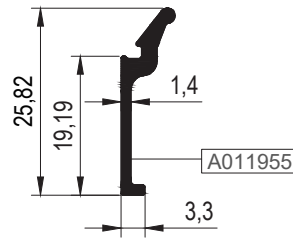

GK35 A 02

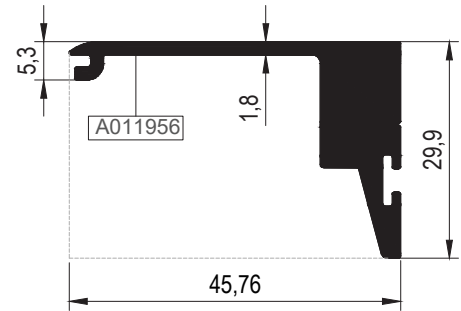

GK35 A 03

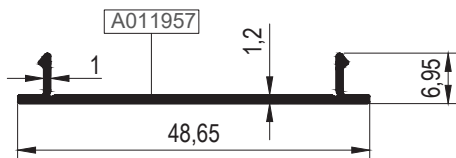

**GK35 G XX

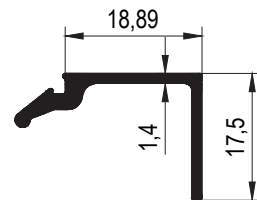

**Kalıp aktif değildir. Sipariş üzerine yapılacaktır.
The die is not active. It will be produced by order.

KÖŞE TAKOZLARI (CORNER CLEATS)

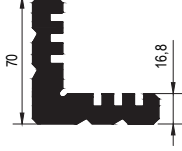
PROFİL KODU (PROFILE CODE)	25 L 38			
FABRİKA KODU (FACTORY CODE)	A002074			
AĞIRLIK (WEIGHT)	4,854 kg/m			
ÇİZİM (DRAWING)				

01

02

03

04

05

06

07

08

09

10

11

MİMARİ KATALOG

ARCHITECTURAL CATALOGUE

Alüminyum Kapı Pencere ve Giydirme Cephe Sistemleri
Aluminium Window Doors and Facade Systems

RGK35

DETAYLAR

DETAILS

01

02

03

04

05

06

07

08

09

10

11

DETAYLAR
DETAILS

RGK35

ÇİFT CAMLI DETAYLAR
DOUBLE GLAZED DETAILS

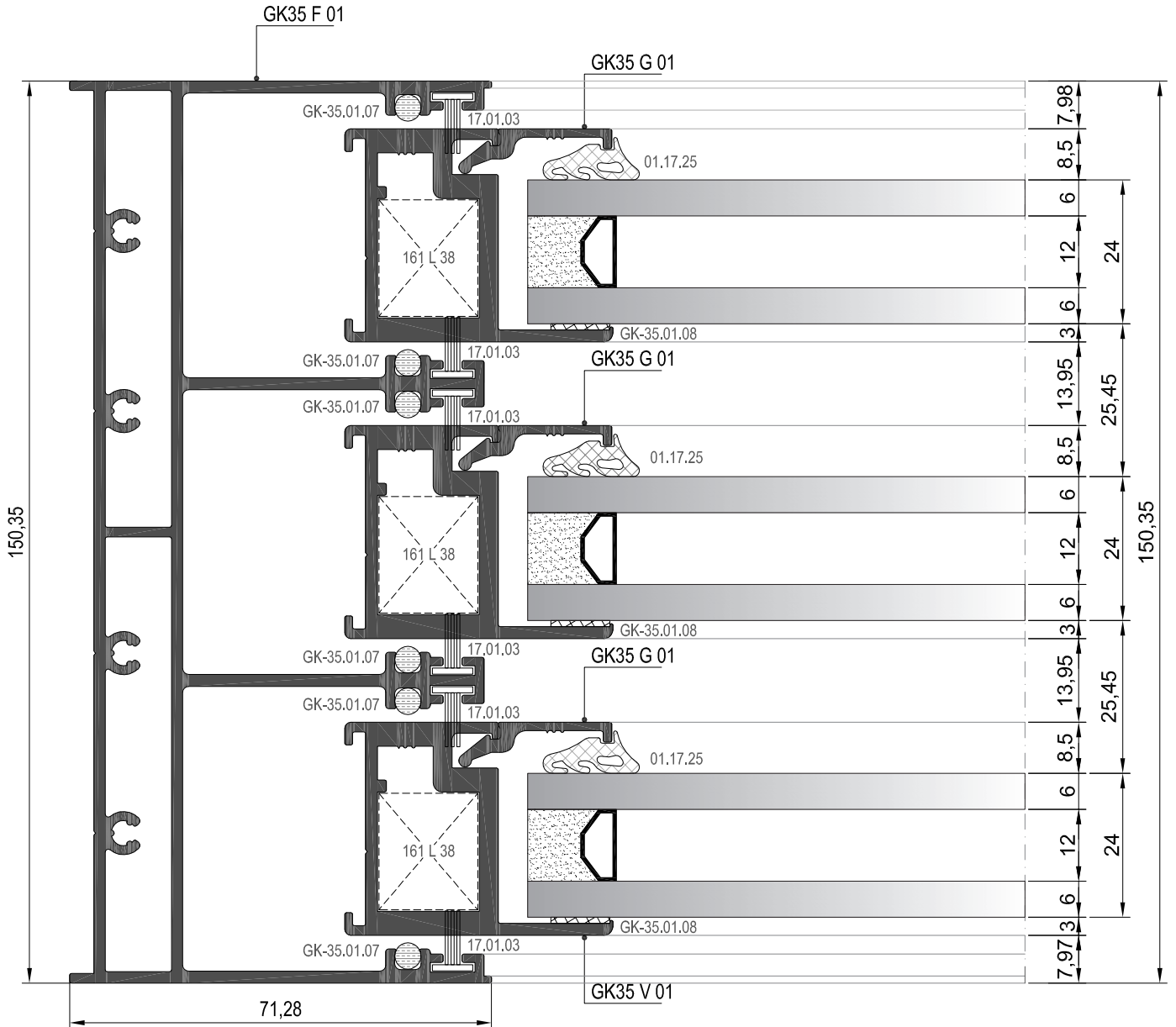
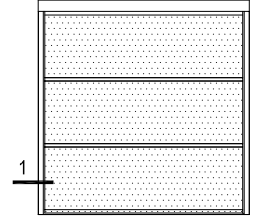

① DETAYI
DETAIL

ÇİFT CAMLI DETAYLAR
DOUBLE GLAZED DETAILS

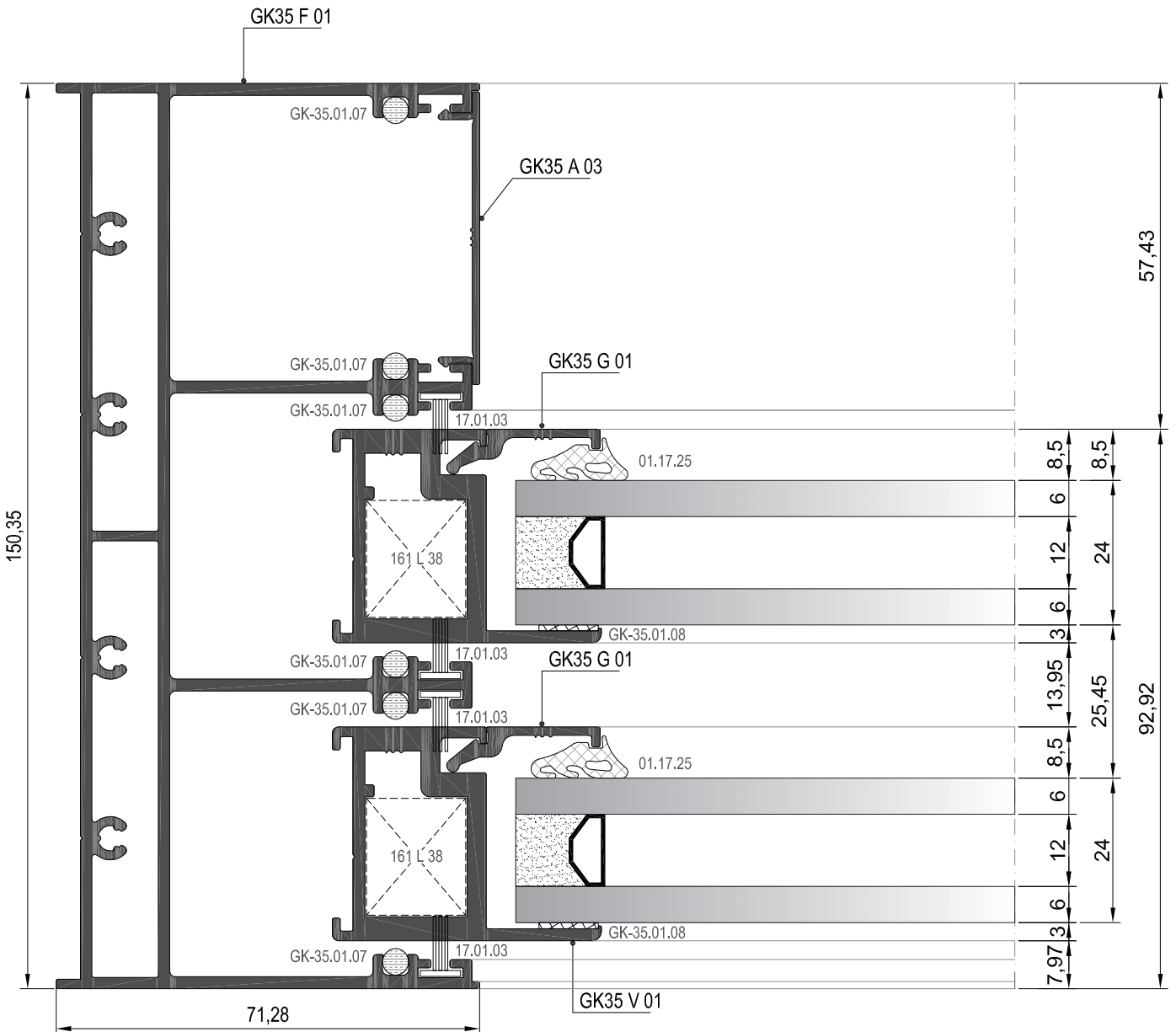
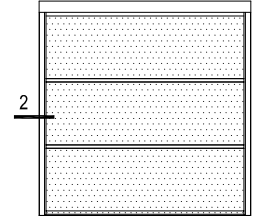

② DETAYI
DETAIL

ÇİFT CAMLI DETAYLAR
DOUBLE GLAZED DETAILS

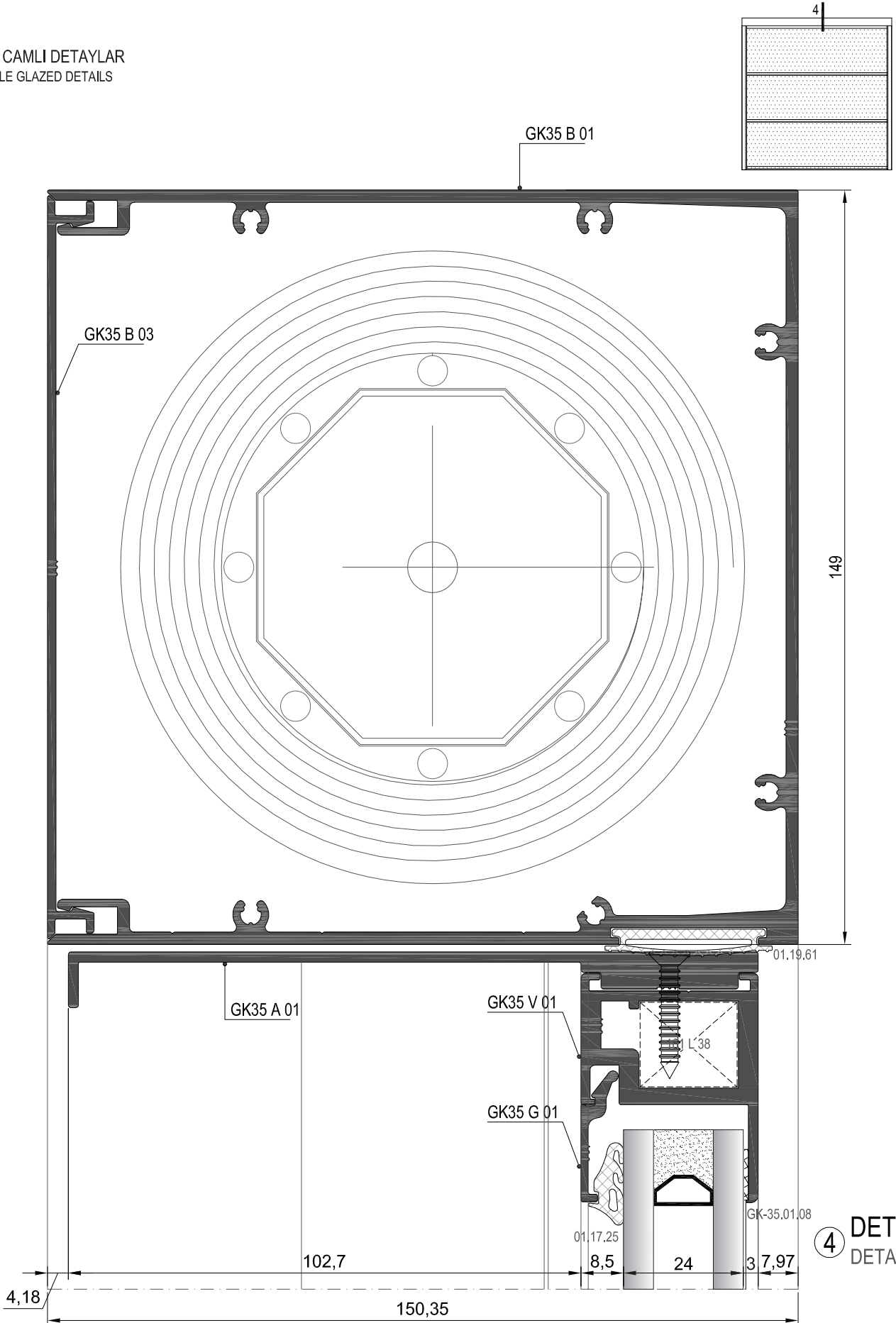

ÇİFT CAMLI DETAYLAR
DOUBLE GLAZED DETAILS

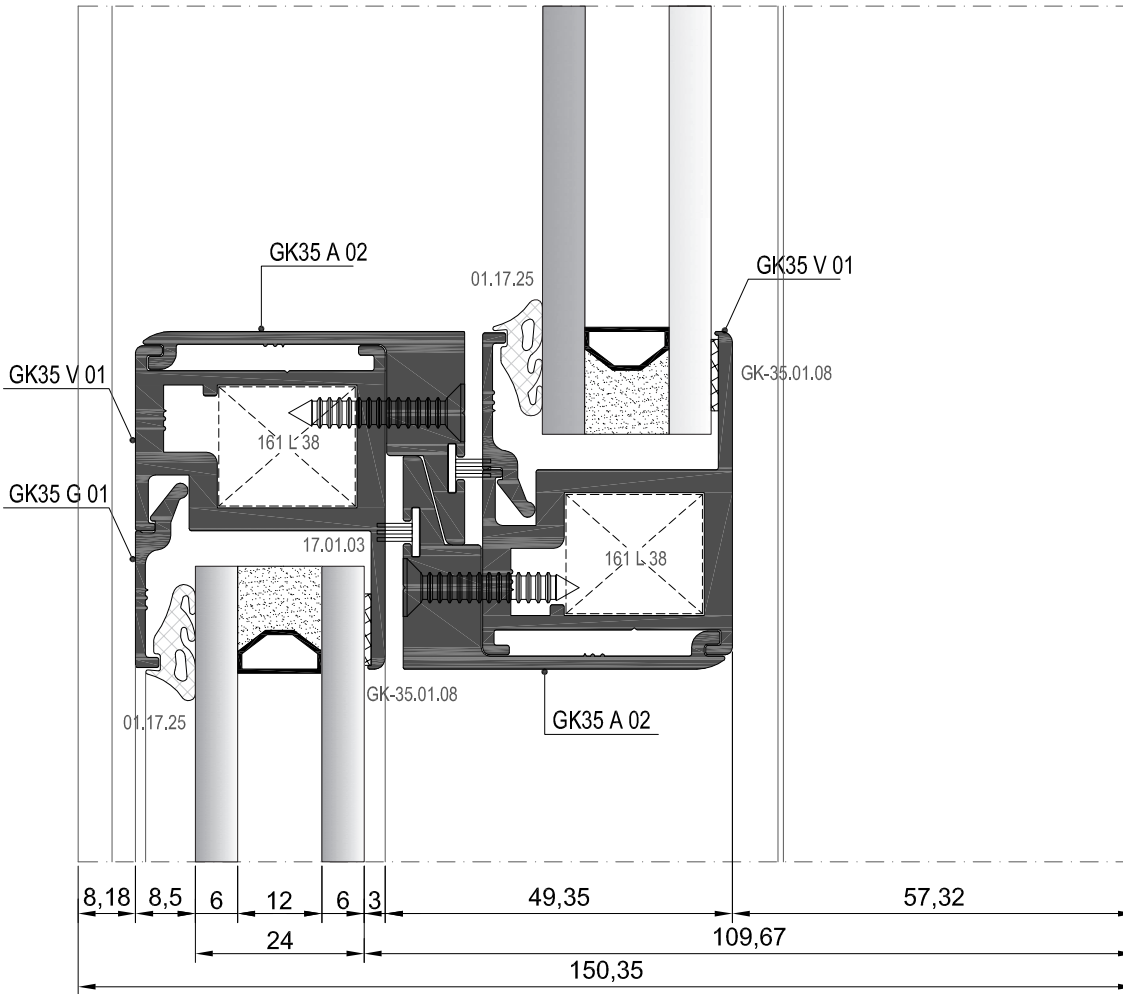
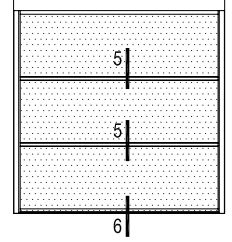

⑤ DETAYI
DETAIL

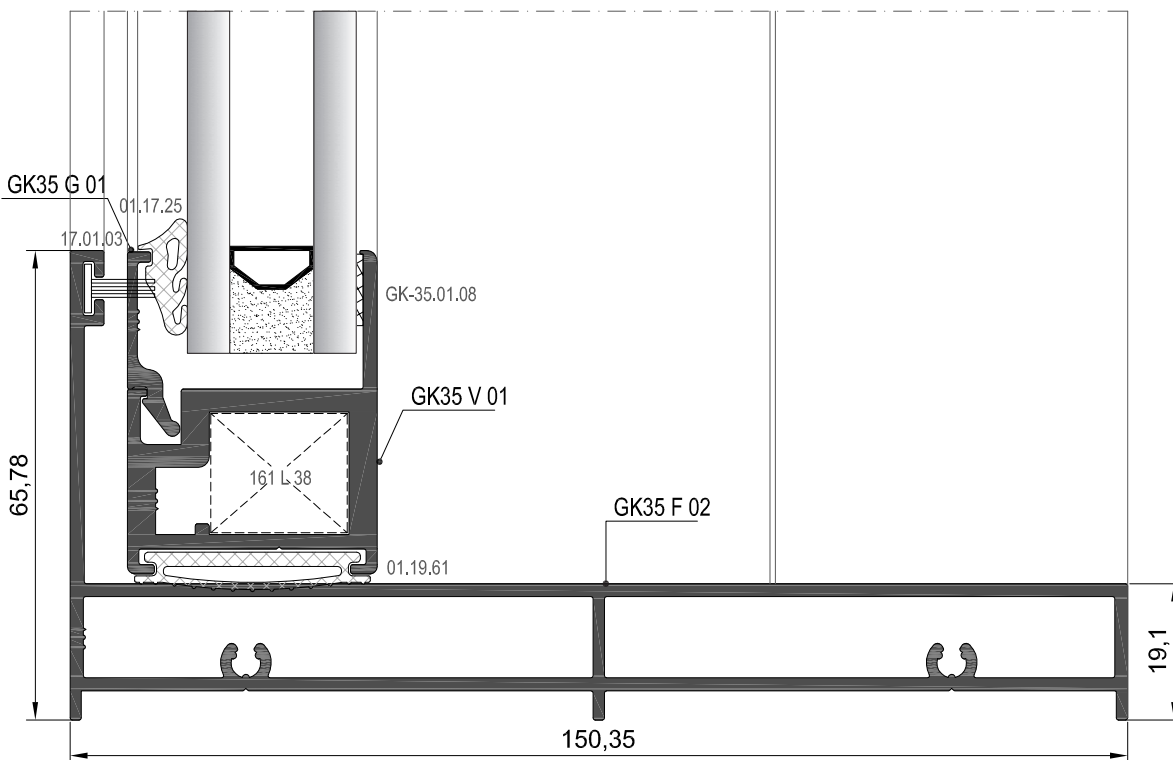

⑥ DETAYI
DETAIL

TEK CAMLI DETAYLAR (10 mm)
SINGLE GLAZED DETAILS (10 mm)

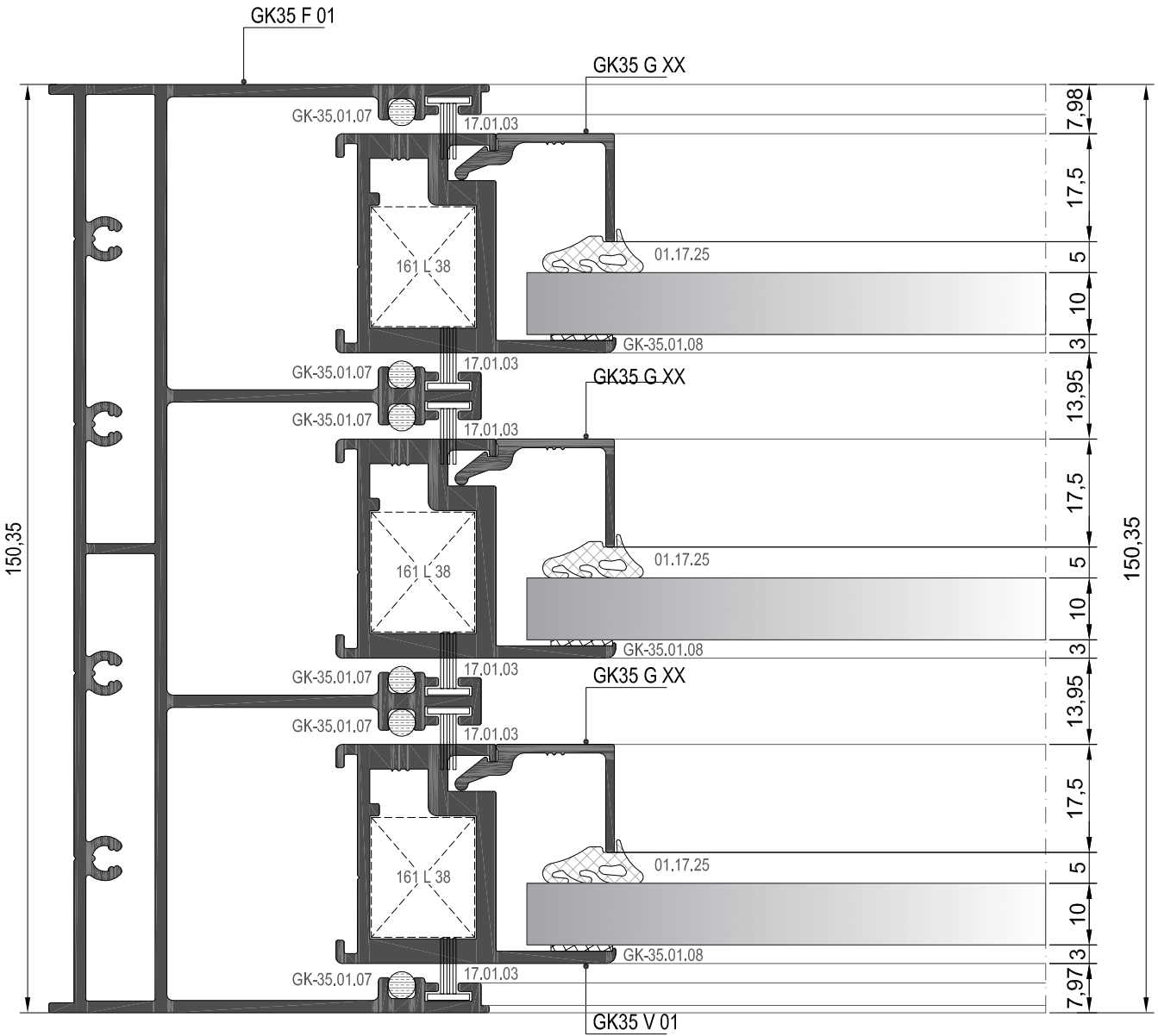
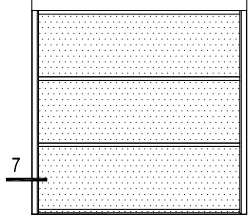

7 DETAYI
DETAIL

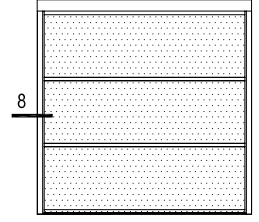

TEK CAMLI DETAYLAR (10 mm)
SINGLE GLAZED DETAILS (10 mm)

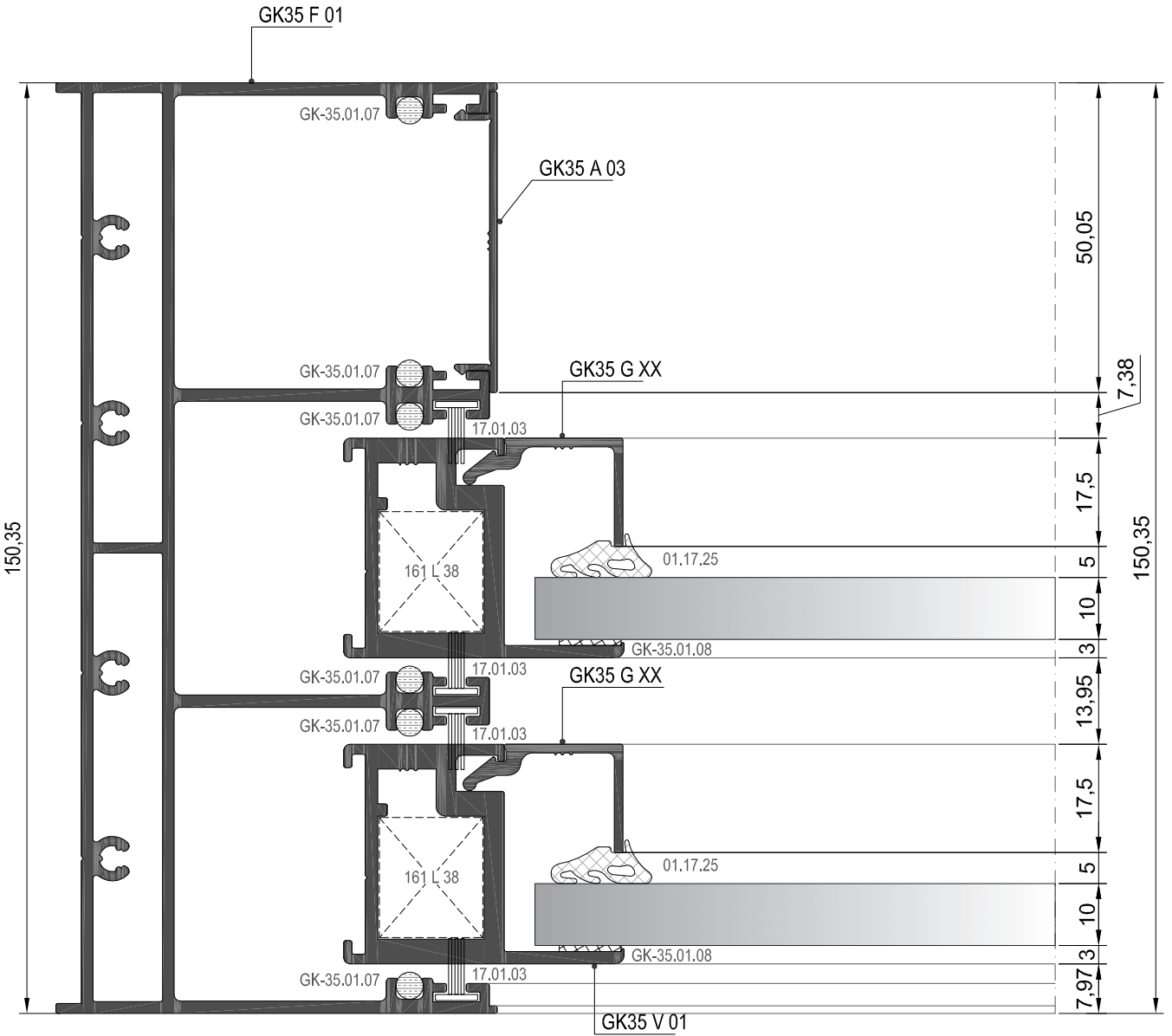

8 DETAYI
DETAIL

DETYLAR
DETAILS

RGK35

TEK CAMLI DETAYLAR (10 mm)
SINGLE GLAZED DETAILS (10 mm)

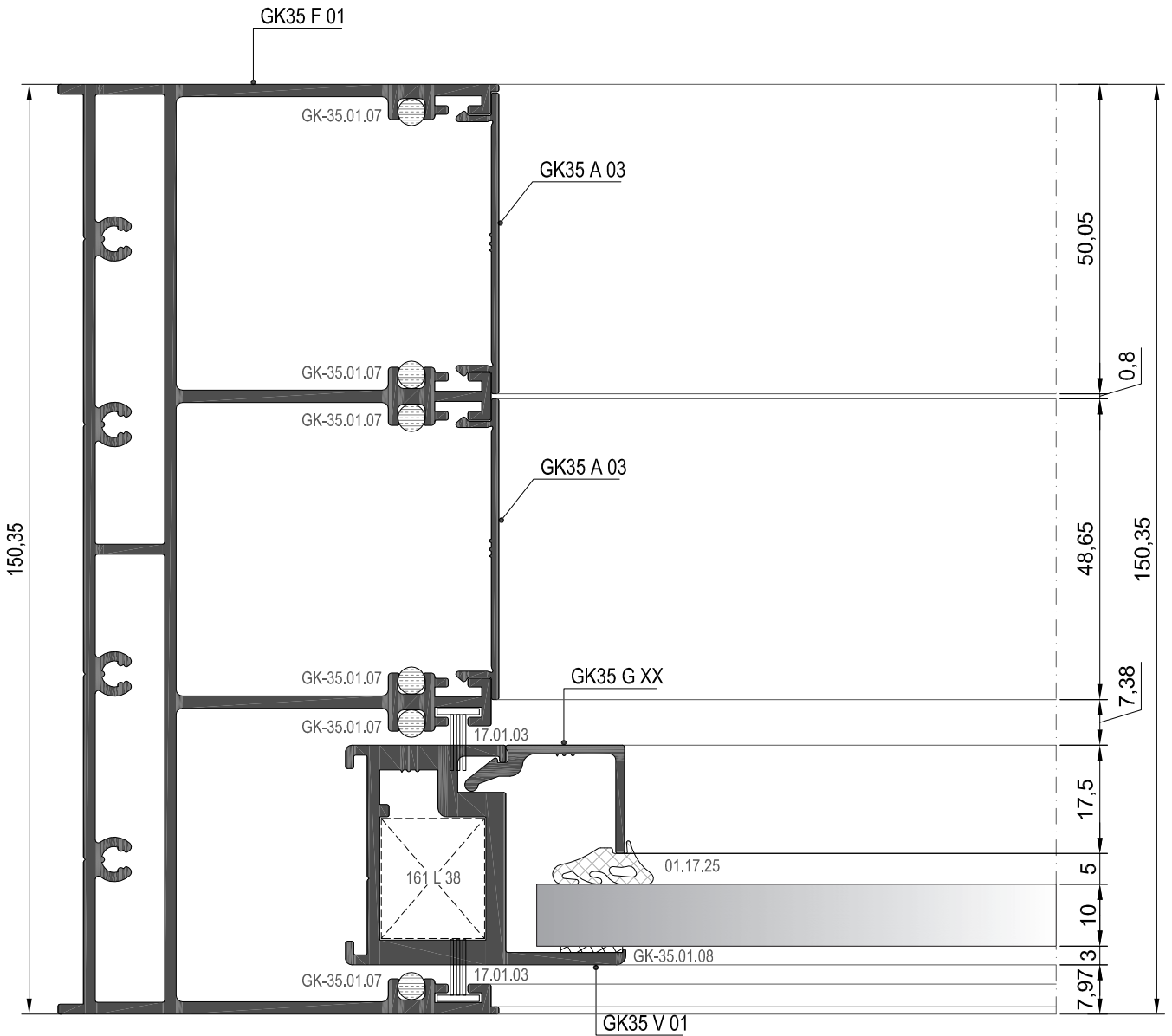
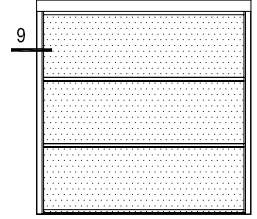

9 DETAYI
DETAIL

01

02

03

04

05

06

07

08

09

10

11

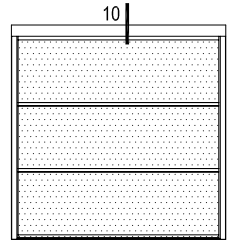

01 TEK CAMLI DETAYLAR (10 mm)
SINGLE GLAZED DETAILS (10 mm)

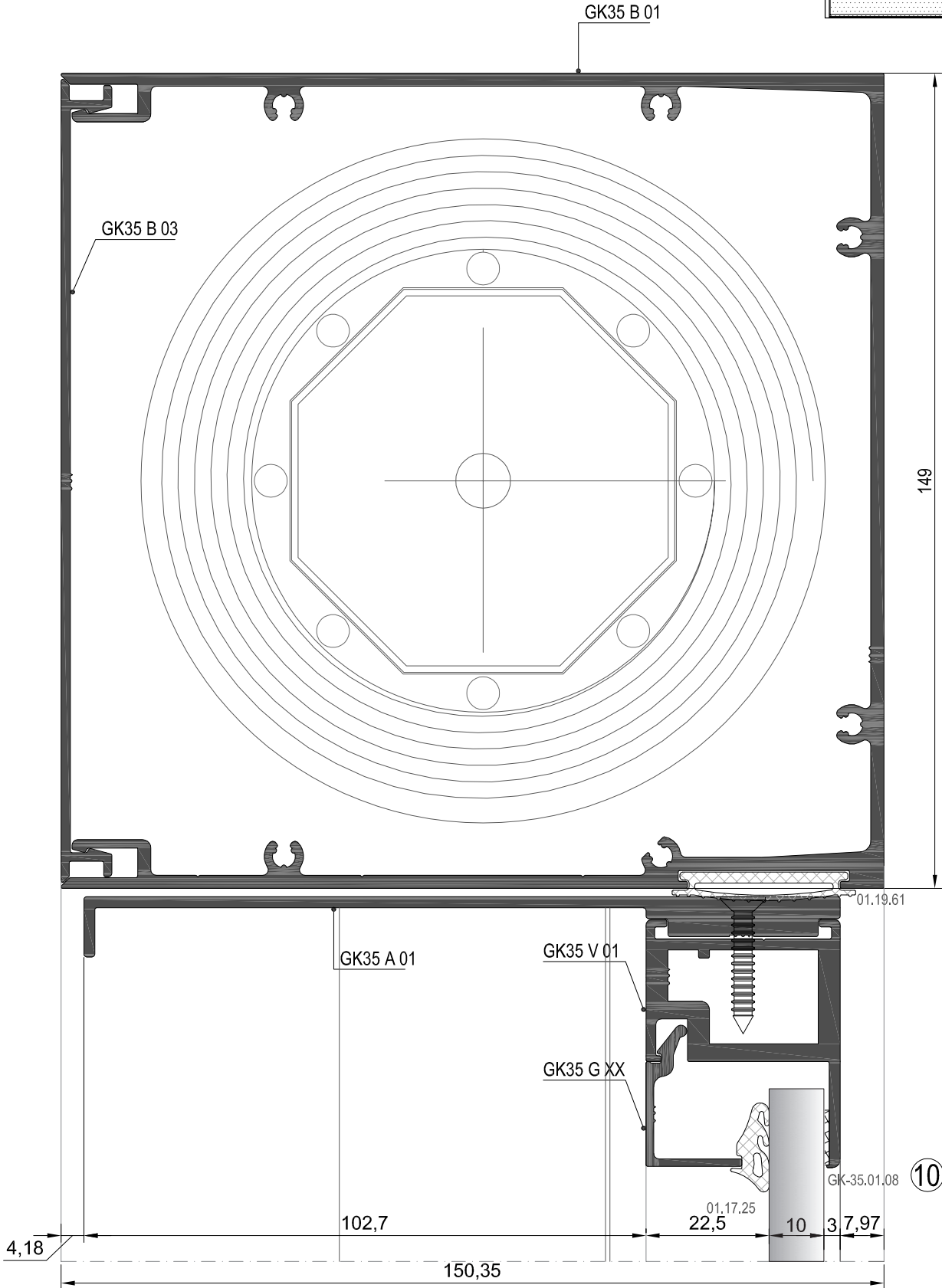

10 DETAYI
DETAIL

DETYLAR
DETAILS

RGK35

TEK CAMLI DETAYLAR (10 mm)
SINGLE GLAZED DETAILS (10 mm)

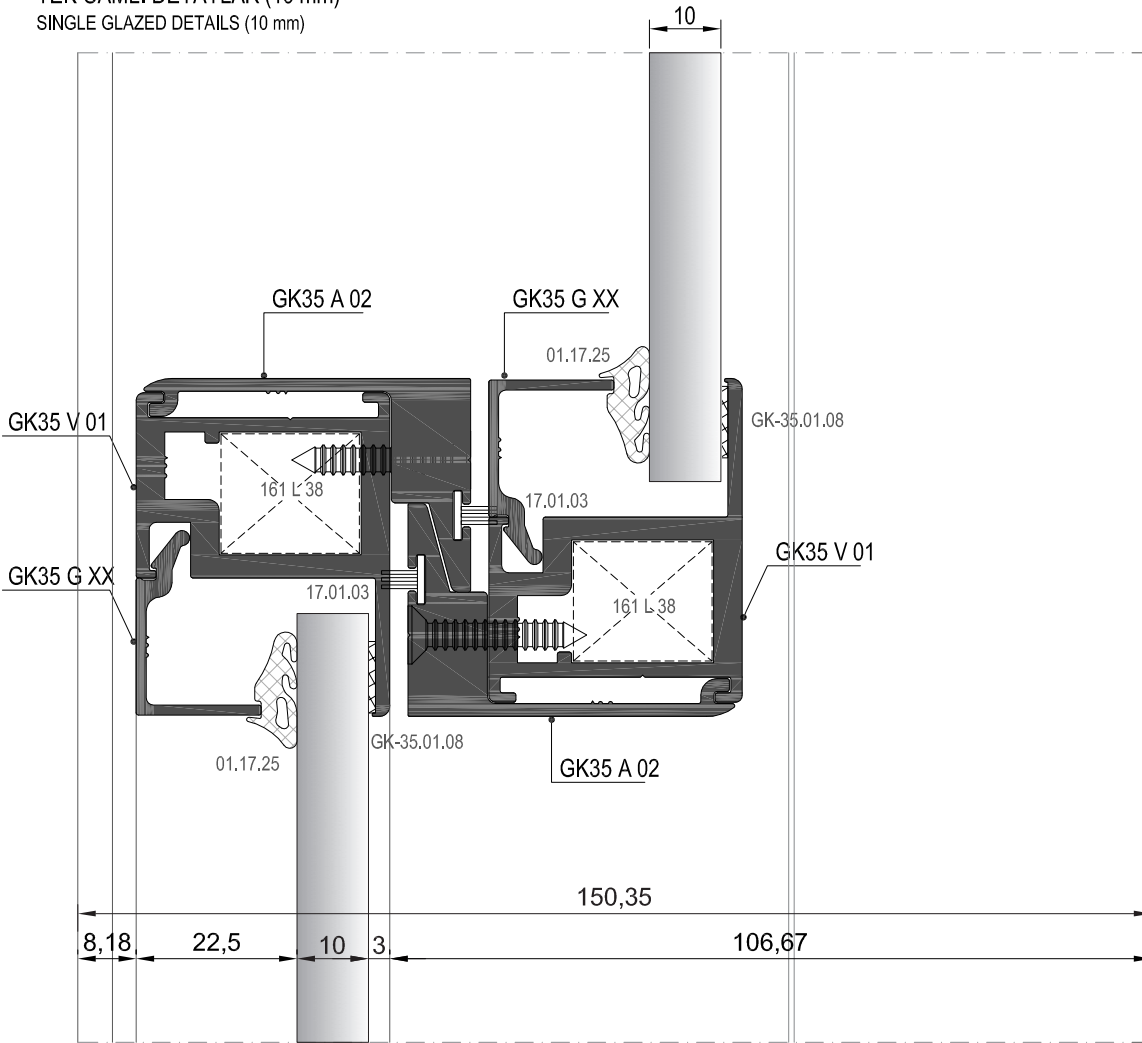

11 DETAYI
DETAIL

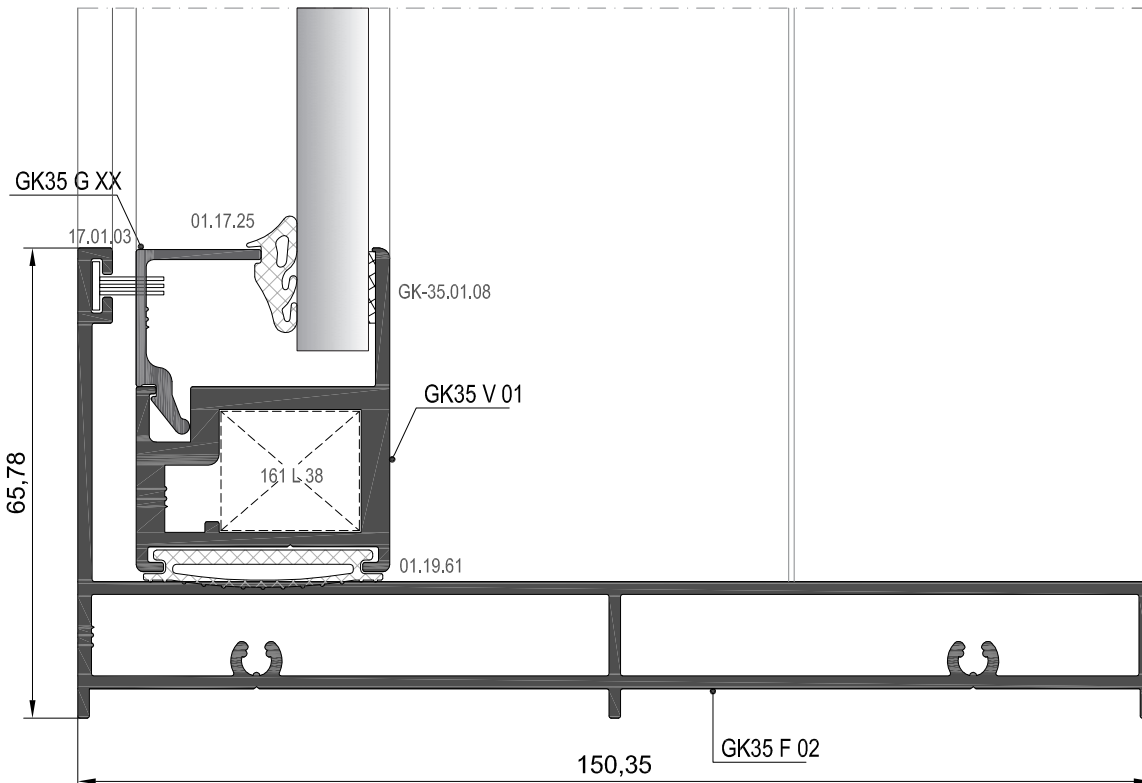

12 DETAYI
DETAIL

01

02

03

04

05

06

07

08

09

10

11

01

TEK CAMLI DETAYLAR (8 mm)
SINGLE GLAZED DETAILS (8 mm)

02

03

04

05

06

07

08

09

10

11

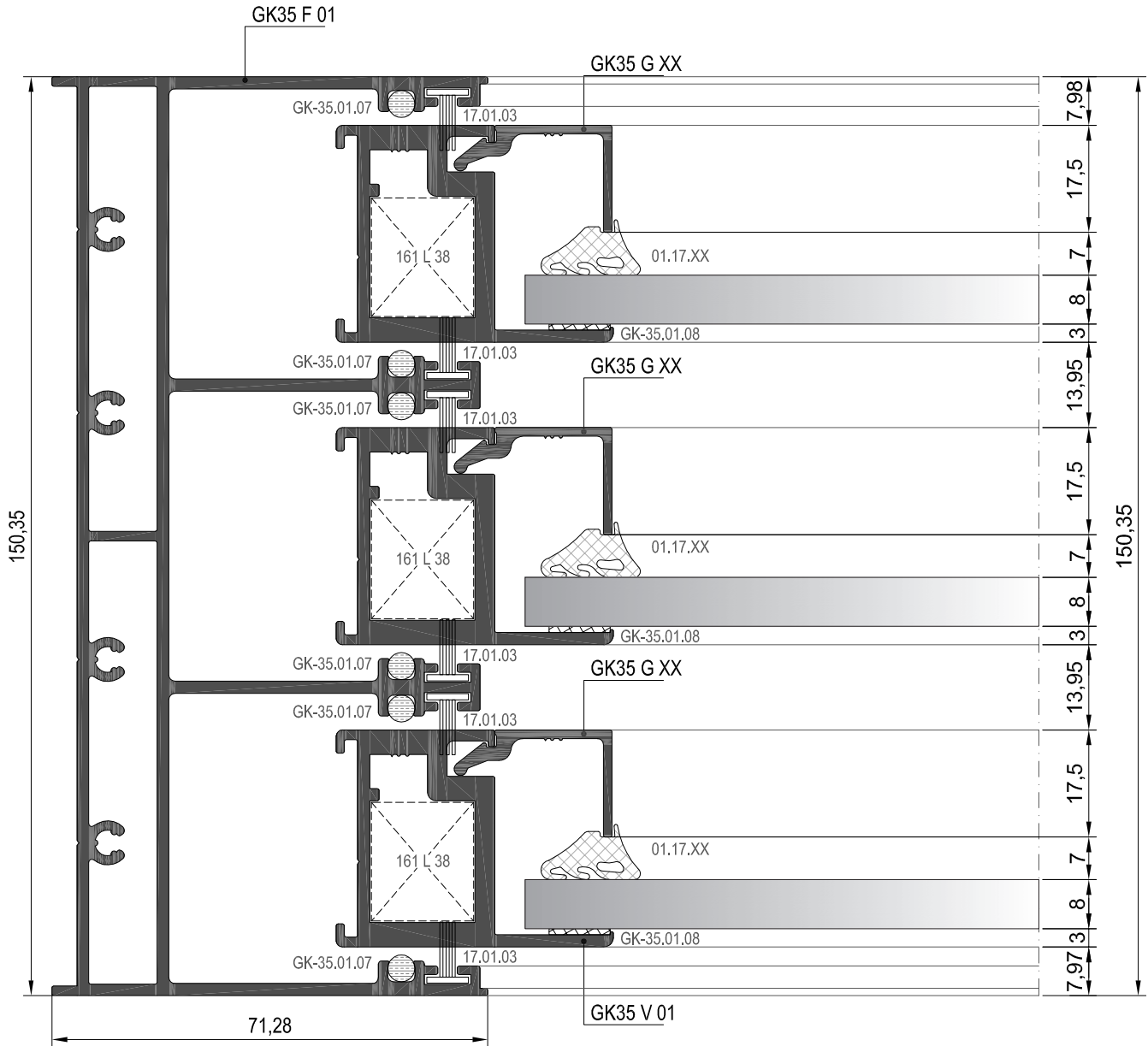
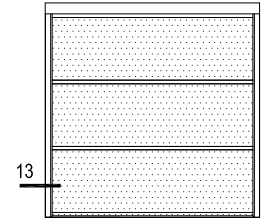

13 DETAYI
DETAIL

DETAYLAR
DETAILS

RGK35

TEK CAMLI DETAYLAR (8 mm)
SINGLE GLAZED DETAILS (8 mm)

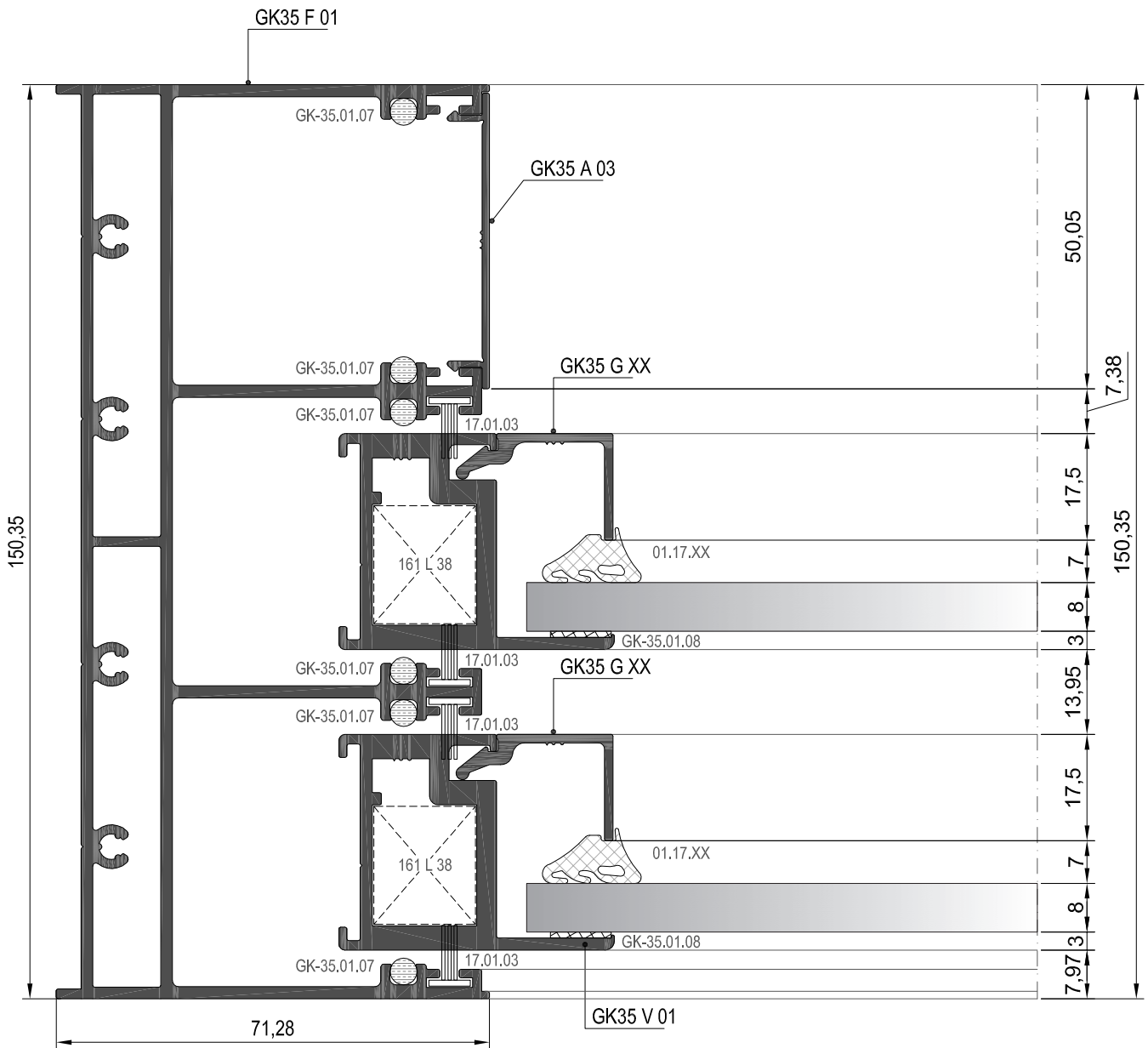
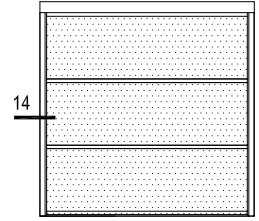

14 DETAYI
DETAIL

01

02

03

04

05

06

07

08

09

10

11

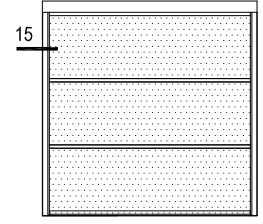

01 TEK CAMLI DETAYLAR (8 mm)
SINGLE GLAZED DETAILS (8 mm)

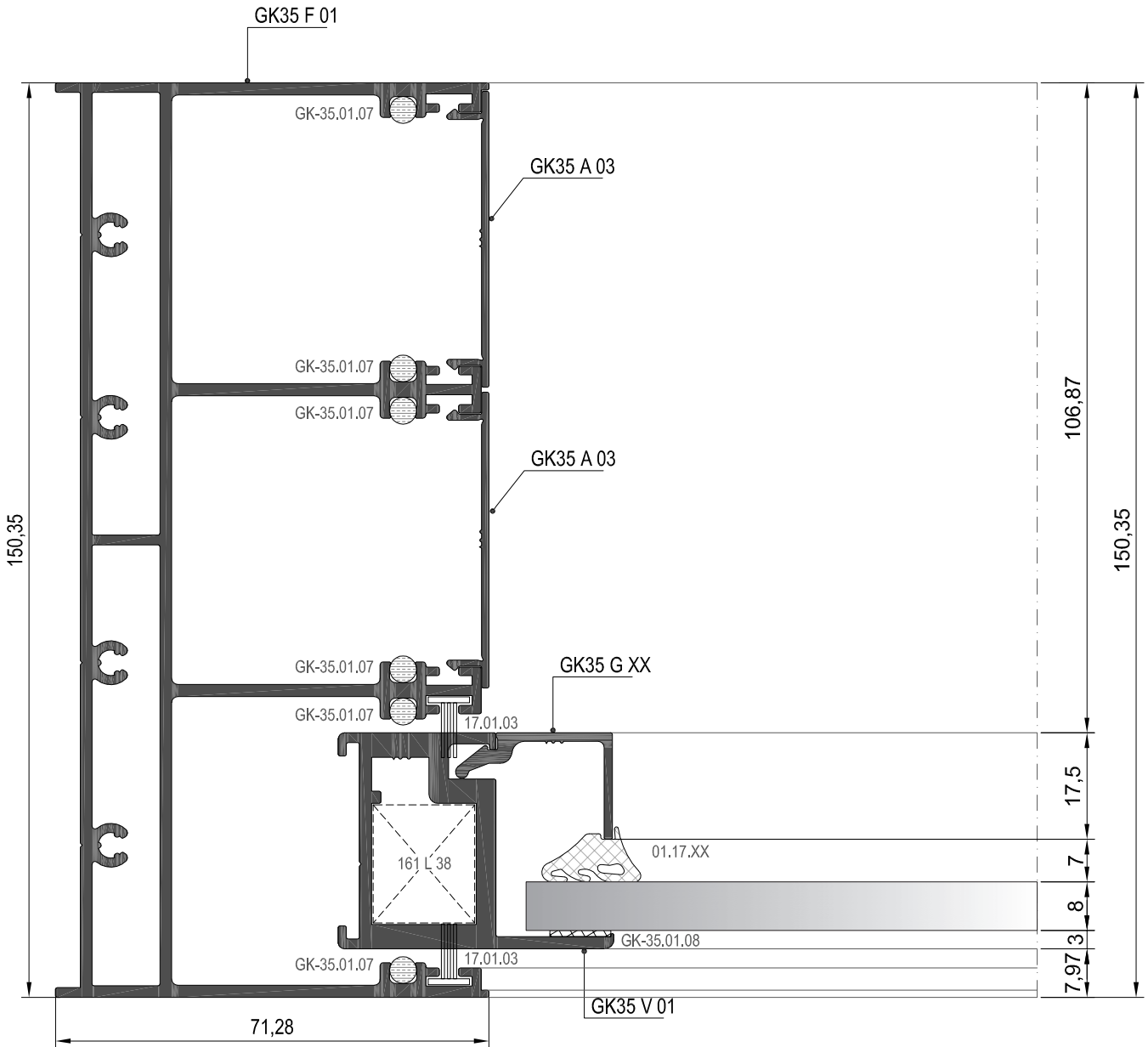

15 DETAYI
DETAIL

TEK CAMLI DETAYLAR (8 mm)
SINGLE GLAZED DETAILS (8 mm)

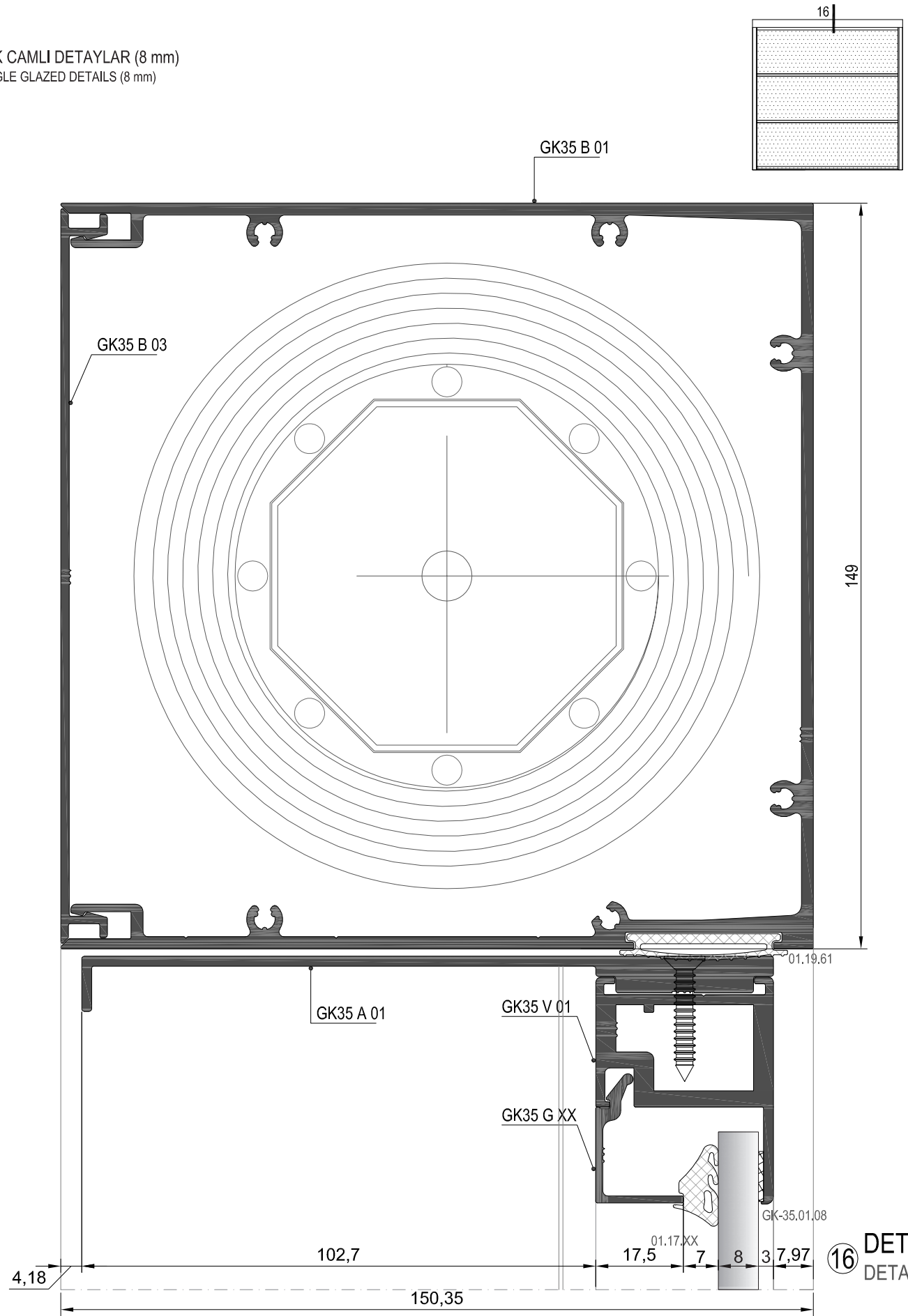

01
02
03
04
05
06
07
08
09
10
11

16 DETAYI
DETAIL

DETAYLAR
DETAILS

RGK35

TEK CAMLI DETAYLAR (8 mm)
SINGLE GLAZED DETAILS (8 mm)

- 01
- 02
- 03
- 04
- 05
- 06
- 07
- 08
- 09
- 10
- 11

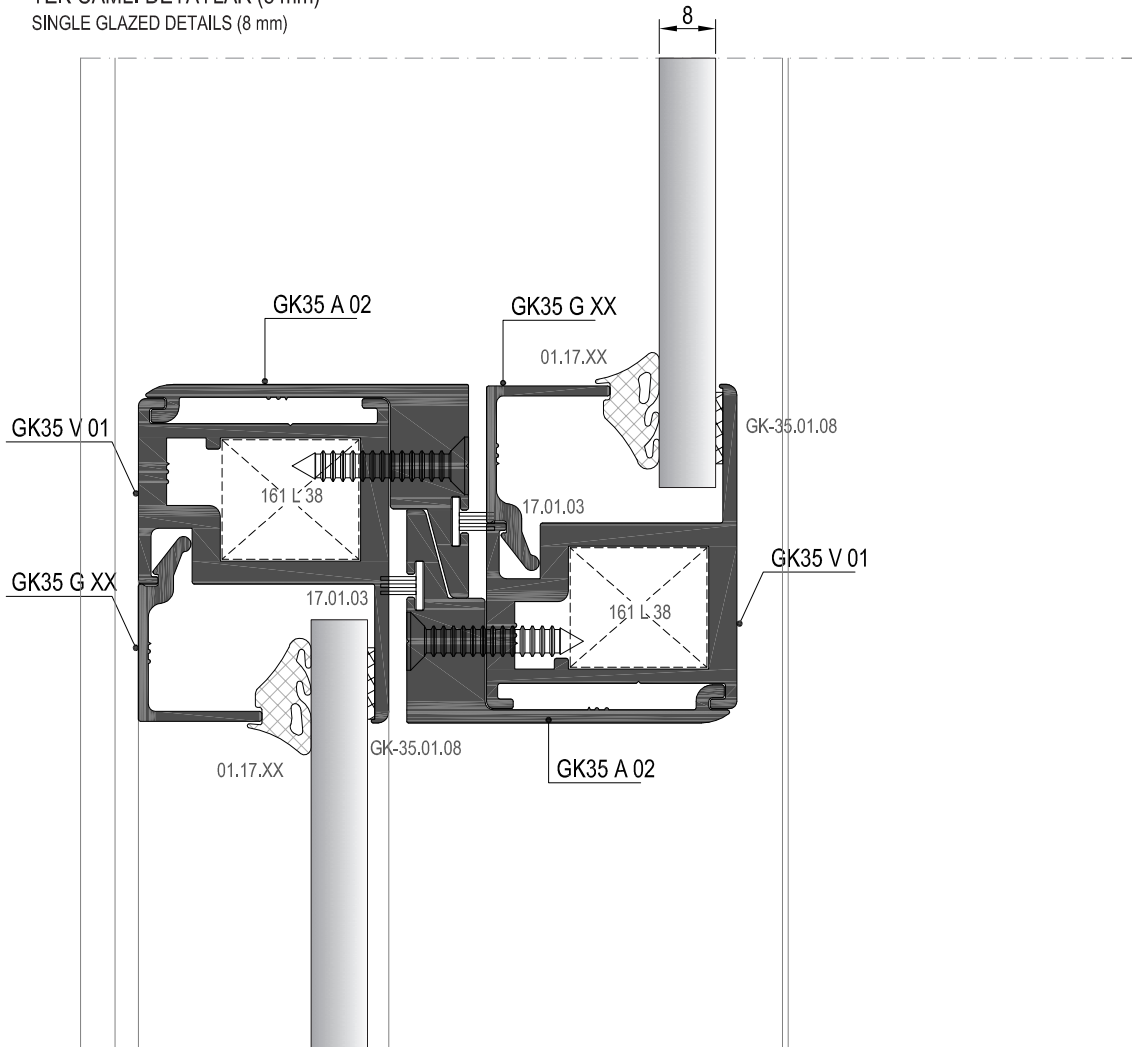
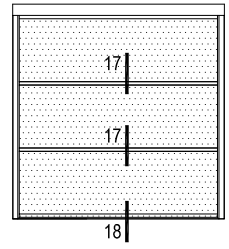

17 DETAYI
DETAIL

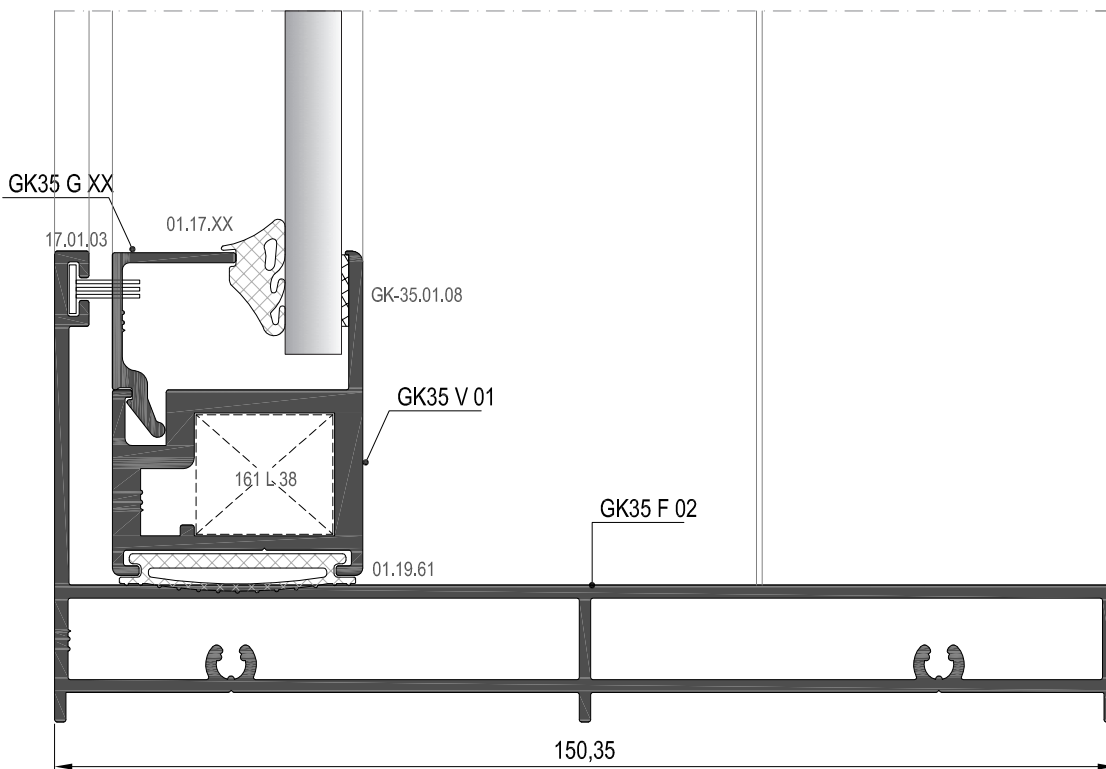

18 DETAYI
DETAIL

MİMARİ KATALOG

ARCHITECTURAL CATALOGUE

Alüminyum Kapı Pencere ve Giydirme Cephe Sistemleri
Aluminium Window Doors and Facade Systems

RGK35

AKSESUARLAR

ACCESSORIES

01

02

03

04

05

06







07



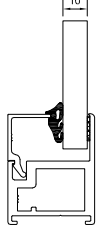

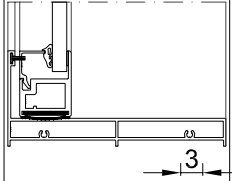
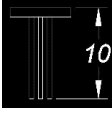
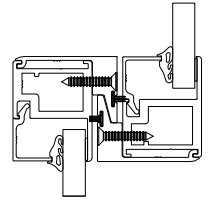

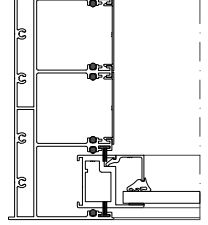

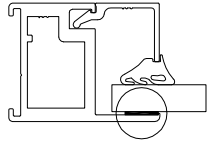



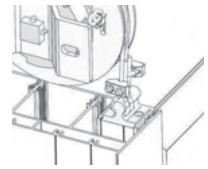
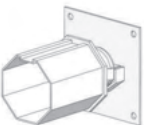
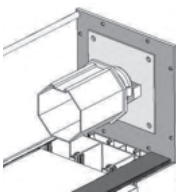

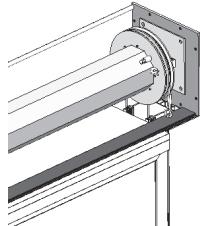
08

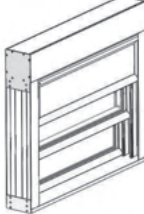
09

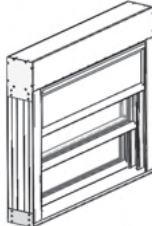
10

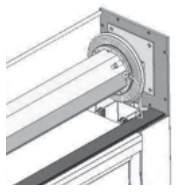
11

01		01.17.25 İÇ CAM FİTİLİ INSIDE GLAZING GASKET Malzeme / Material : EPDM Ağırlık / Weight : 77 gr/m Paket / Package: 194,8 m / 15 kg				
02						
03		01.19.61 ALT ÜST KASA FİTİLİ DOWN UP FRAME GASKET Malzeme / Material : EPDM Ağırlık / Weight : 131 gr/m Paket / Package: 114,5 m / 15 kg				
04						
05		17.01.03 KIL FİTİL 67x1000 BRUSH Malzeme / Material Polipropilen / Polypropilene Paket / Package: 800 m				
06						
07		GK-35.01.07 FİTİL Ø4,5 GASKET Ø4,5 Malzeme / Material : Poliksümetilen Paket / Package: 3 m				
08		GK-35.01.08 ÇİFT TARAFLI RULO BANT DOUBLE SIDED ROLL TAPE 10mmx1mm Paket / Package: 50m				
09						
10						
11						

	GK-35.01.01 NATUROLL TUP MOTOR NATUROLL TUBE MOTOR			GK-35.01.11 HALAT TASIMA PARÇASI ROPE CARRYING PARTS	
	GK-35.01.02 TUP MOTOR BAĞLANTI AKSESUARI TUBE MOTOR CONNECTION ACCESSORIES Paket/Package:1 takım			GK-35.01.12 NATUROLL TUP MOTOR KUMANDASI NATUROLL TUBE MOTOR REMOTE CONTROL	TEK KANALLI VERİCİ TRANSMITTER, SINGLE CHANNEL
	GK-35.01.03 KASNAK GRUBU PULLEY GROUP Paket/Package:1 takım(2 kasnak grubu)			GK-35.01.13 NATUROLL TUP MOTOR KUMANDASI NATUROLL TUBE MOTOR REMOTE CONTROL	TEK TEK VEYA GRUP KONTROL ÖZELLİĞİ OLAN 4 KANALLI VERİCİ TRANSMITTER, 4 CHANNELS, INDIVIDUAL AND GROUP CONTROL FUNCTION
	GK-35.01.04-1 YAN KAPAKLAR(üst) SIDE CAPS			GK-35.01.14 NATUROLL TUP MOTOR KUMANDASI NATUROLL TUBE MOTOR REMOTE CONTROL	TEK TEK VEYA GRUP KONTROL ÖZELLİĞİ OLAN LCD EKРАНLI 4 KANALLI VERİCİ TRANSMITTER, 4 CHANNELS, LCD DISPLAY, INDIVIDUAL AND GROUP CONTROL FUNCTION
	GK-35.01.04-2 YAN KAPAKLAR(alt) SIDE CAPS			GK-35.01.15 NATUROLL TUP MOTOR KUMANDASI NATUROLL TUBE MOTOR REMOTE CONTROL	TEK TEK VEYA GRUP KONTROL ÖZELLİĞİ OLAN LCD EKРАНLI 8 KANALLI VERİCİ TRANSMITTER, 8 CHANNELS, LCD DISPLAY, INDIVIDUAL AND GROUP CONTROL FUNCTION
	GK-35.01.05 ÇELİK HALAT STEEL ROPE Ø3, 4adet x 2,5m Çelik Halat 250 kg dayanıkl			GK-35.01.16 NATUROLL TUP MOTOR KUMANDASI NATUROLL TUBE MOTOR REMOTE CONTROL	TEK TEK VEYA GRUP KONTROL ÖZELLİĞİ OLAN LCD EKРАНLI 16 KANALLI VERİCİ TRANSMITTER, 16 CHANNELS, LCD DISPLAY, INDIVIDUAL AND GROUP CONTROL FUNCTION
	GK-35.01.06 TAMBUR BORUSU DRUM PIPE 6500 mm			GK-35.01.17 NATUROLL TUP MOTOR KUMANDASI NATUROLL TUBE MOTOR REMOTE CONTROL	TEK KANALLI 8 FARKLI AÇMA KAPAMALI ZAMAN AYARLAYICI LCD EKРАНLI VERİCİ TRANSMITTER, SINGLE CHANNEL, LCD DISPLAY, TIMER FUNCTION, 8 DIFFERENT OPEN&CLOSE TIME

01

02

03

04

05

06



07

08

09

10

11

01		GK-35.01.18 NATUROLL TÜP MOTOR KUMANDASI NATUROLL TUBE MOTOR REMOTE CONTROL	TEK TEK VEYA 4 KANALLI 8 FARKLI AÇMA KAPAMALI ZAMAN AYARLAYICI LCD EKRANLI VERİCİ TRANSMITTER, 4 CHANNELS, LCD DISPLAY, TIMER FUNCTION, 8 DIFFERENT OPEN&CLOSE TIME			
02						
03		GK-35.01.19 NATUROLL TÜP MOTOR KUMANDASI ALICISI NATUROLL TUBE MOTOR REMOTE CONTROL RECEIVER	GARAJ TİPİ DUVAR ALICI RECEIVER FOR GARAGE DOOR APPLICATION			
04						
05						
06						
07						
08						
09						
10						
11						

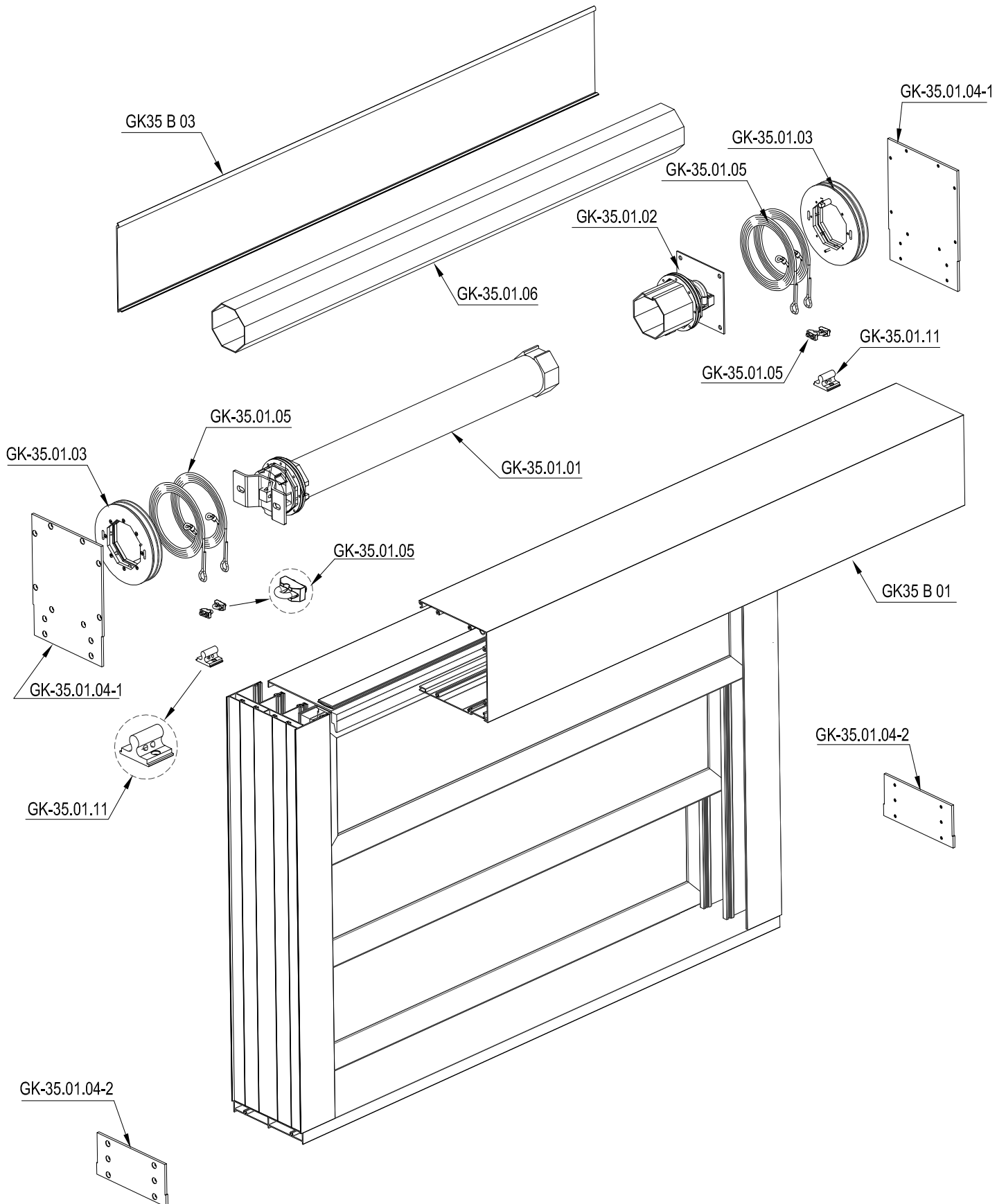

01

02

03

04

05

06

07

08

09

10

11

HAREKET MEKANİZMASI SETİ
MOVEMENT MECHANISM SET

	KOD CODE	TANIM DESCRIPTION	ADET NUMBER	TAKIM SET
1	GK-35.01.01	TÜP MOTOR TUBE MOTOR	1	
2	GK-35.01.02	TÜP MOTOR BAĞLANTI AKSESUARI TUBE MOTOR CONNECTION ACCESSORIES		1
3	GK-35.01.03	KASNAK GRUBU PULLEY GROUP		1
4	GK-35.01.04-1	YAN KAPAKLAR(ÜST) SIDE CAPS (UP)	2	
5	GK-35.01.04-2	YAN KAPAKLAR(ALT) SIDE CAPS (DOWN)	2	
6	GK-35.01.05	ÇELİK HALAT STEEL ROPE	4	
7	GK-35.01.06	TAMBUR BORUSU - 6500 mm DRUM PIPE - 6500 mm	1	
8	GK-35.01.11	HALAT TAŞIMA MEKANİZMASI ROPE CARRYING MECHANISM	2	
9	GK-35.01.07	FİTİL GASKET	12	