

# MİMARİ KATALOG ARCHITECTURAL CATALOGUE

Alüminyum Kapı Pencere ve Giydirme Cephe Sistemleri  
Aluminium Window Doors and Facade Systems



# RO73



# MİMARİ KATALOG

## ARCHITECTURAL CATALOGUE

Alüminyum Kapı Pencere ve Giydirme Cephe Sistemleri  
Aluminium Window Doors and Facade Systems

# RO73

PROFİLLER

PROFILES

01

02

03

04

05

06

07

08

09

10

11

KASA VE ADAPTÖR PROFİLLERİ  
FRAME AND ADAPTER PROFILES

# R073

KOD / CODE	AĞIRLIK (kg/m) / WEIGHT	Jxx cm4	Jyy cm4	L m
RO F 01	1,110	6,599	18,194	6
RO A 01	0,208	---	---	6
RO A 02	0,271	---	---	6
RO A 03	0,234	---	---	6
RO A 05	1,214	---	---	6

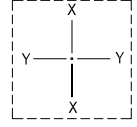

RO F 01

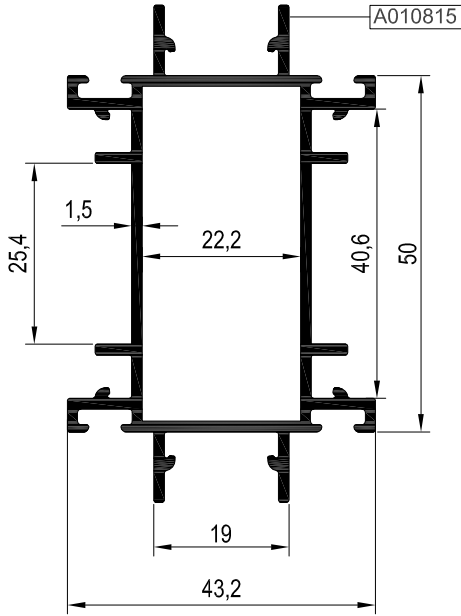

RO A 01

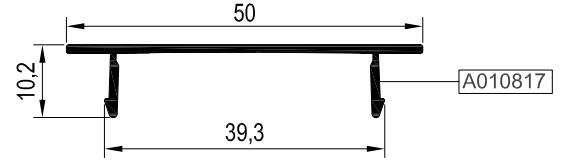

RO A 02

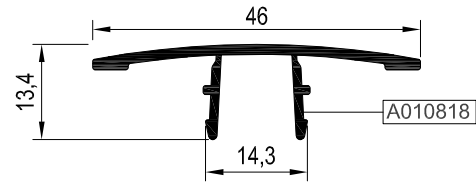

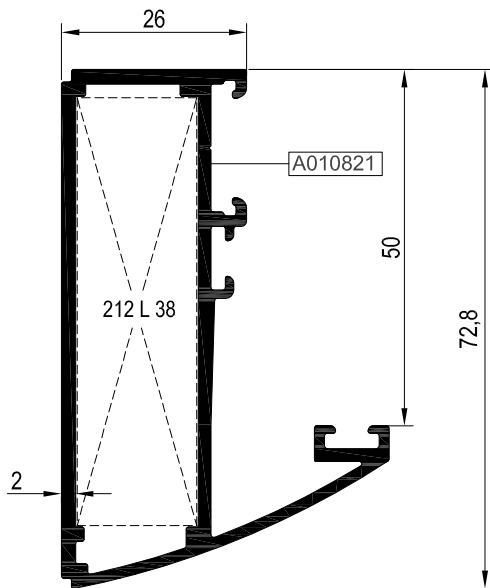

RO A 05

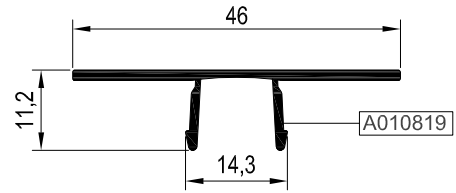

RO A 03



Nr	 L m	KEŞİM ÖLÇÜSÜ CUTTING SIZE	 AKS. KODU ACS. CODE	
RO A 05	A010821	25 L 38 (A002074)	59,8 mm	212 L 38

ETEK VE ADAPTÖR PROFİLLERİ  
KICK PLATE AND ADAPTER PROFILES

# R073

KOD / CODE	AĞIRLIK (kg/m) / WEIGHT	Jxx cm4	Jyy cm4	L m
RO K 01	2,637	---	---	6
RO A 04	0,647	---	---	6

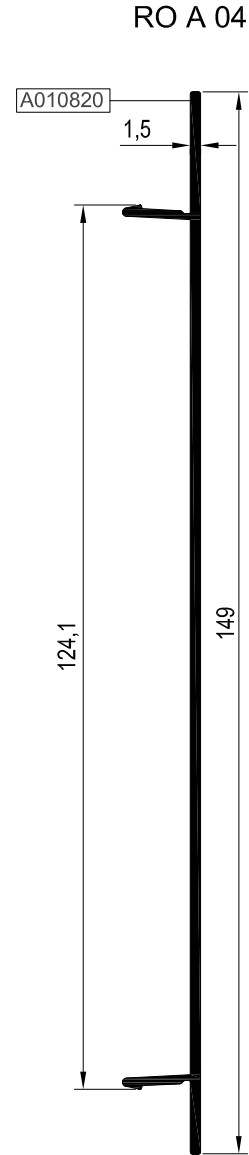
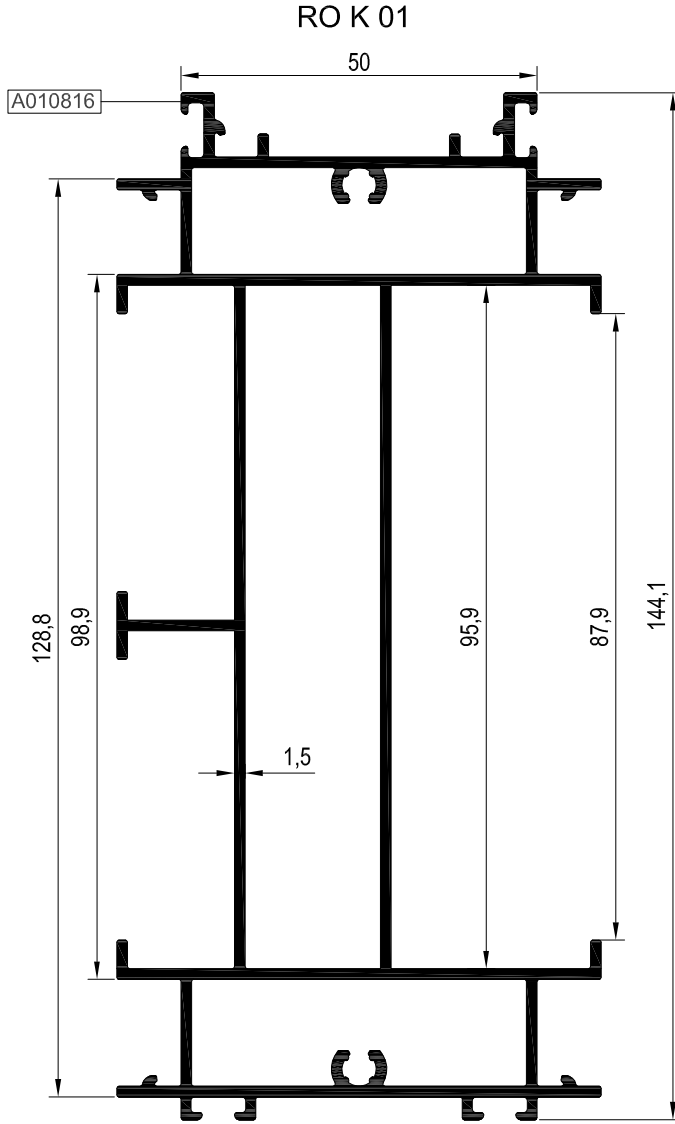
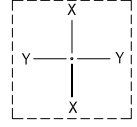

01

02

03

04

05

06

07

08

09



10

11

## TAKOZLAR (CLEATS)

PROFİL KODU (PROFILE CODE)	25 L 38			
FABRİKA KODU (FACTORY CODE)	A002074			
AĞIRLIK (WEIGHT)	4,854 kg/m			
ÇİZİM (DRAWING)				

## KÖŞE TAKOZLARI (CORNER CLEATS)

Nr			KESİM ÖLÇÜSÜ CUTTING SIZE		AKS. KODU ACS. CODE
RO A 05	A010821	25 L 38 (A002074)	59,8 mm		212 L 38

# MİMARİ KATALOG

## ARCHITECTURAL CATALOGUE

Alüminyum Kapı Pencere ve Giydirme Cephe Sistemleri  
Aluminium Window Doors and Facade Systems

# RO73

DETAYLAR

DETAILS

01

02

03

04

05

06

07

08

09

10

11

- 01
- 02
- 03
- 04
- 05
- 06
- 07
- 08
- 09
- 10
- 11

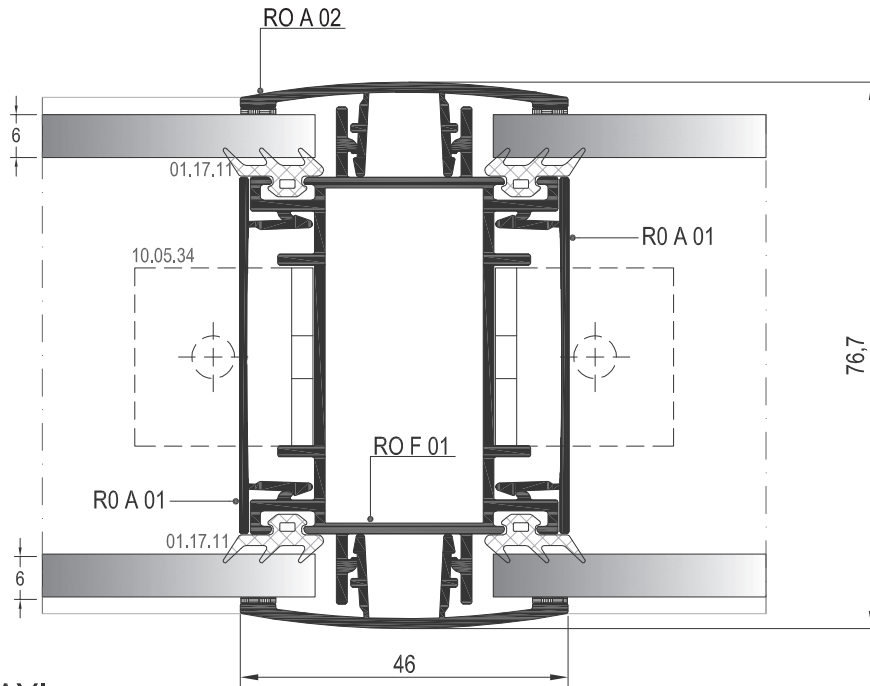
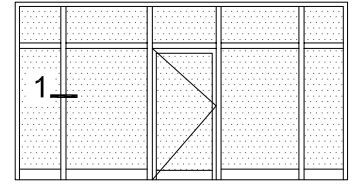

① DETAYI  
DETAIL

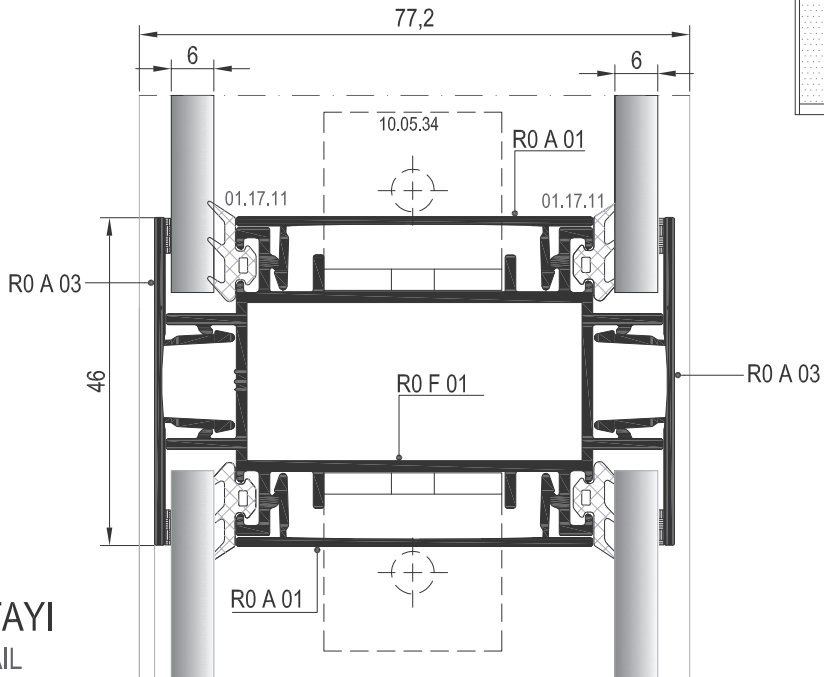
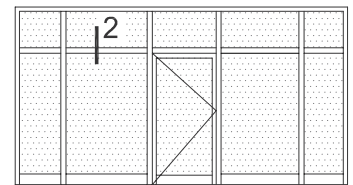

② DETAYI  
DETAIL



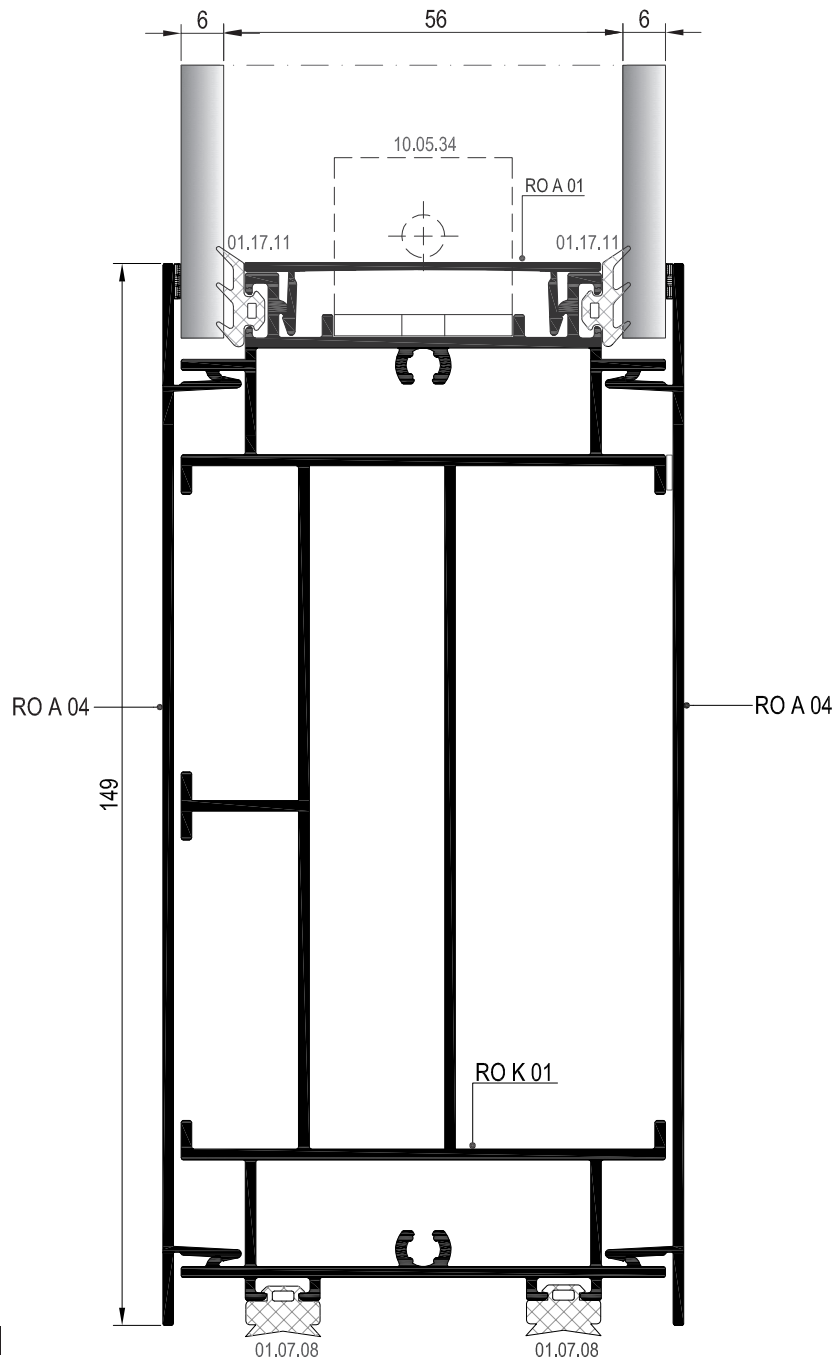
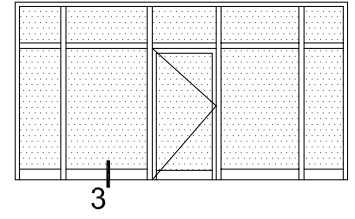

③ DETAYI  
DETAIL

01

02

03

04

05

06

07

08

09

10

11

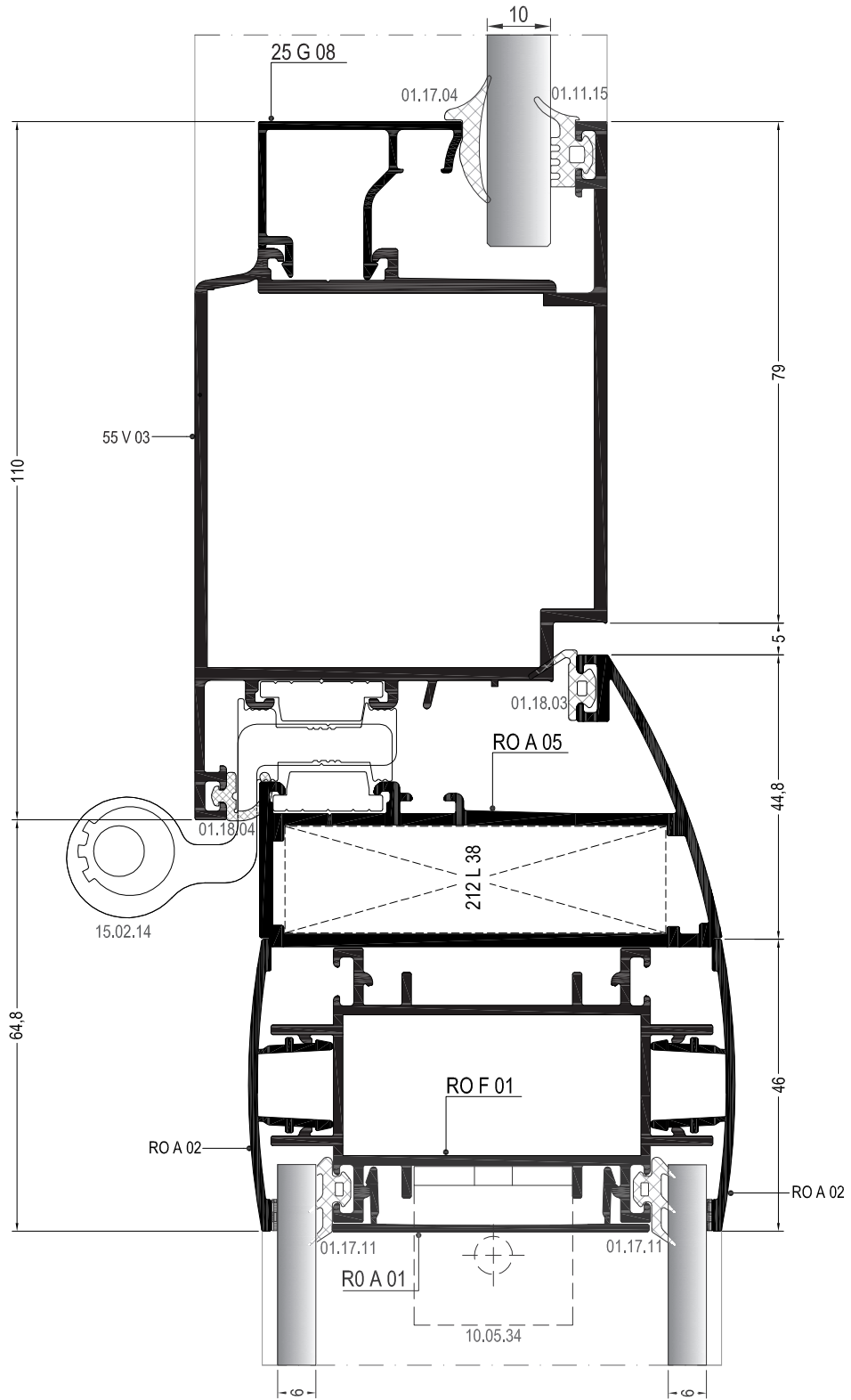
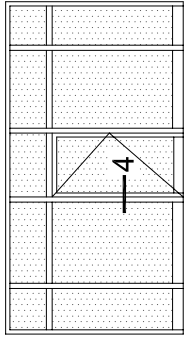

④ DETAYI  
DETAIL

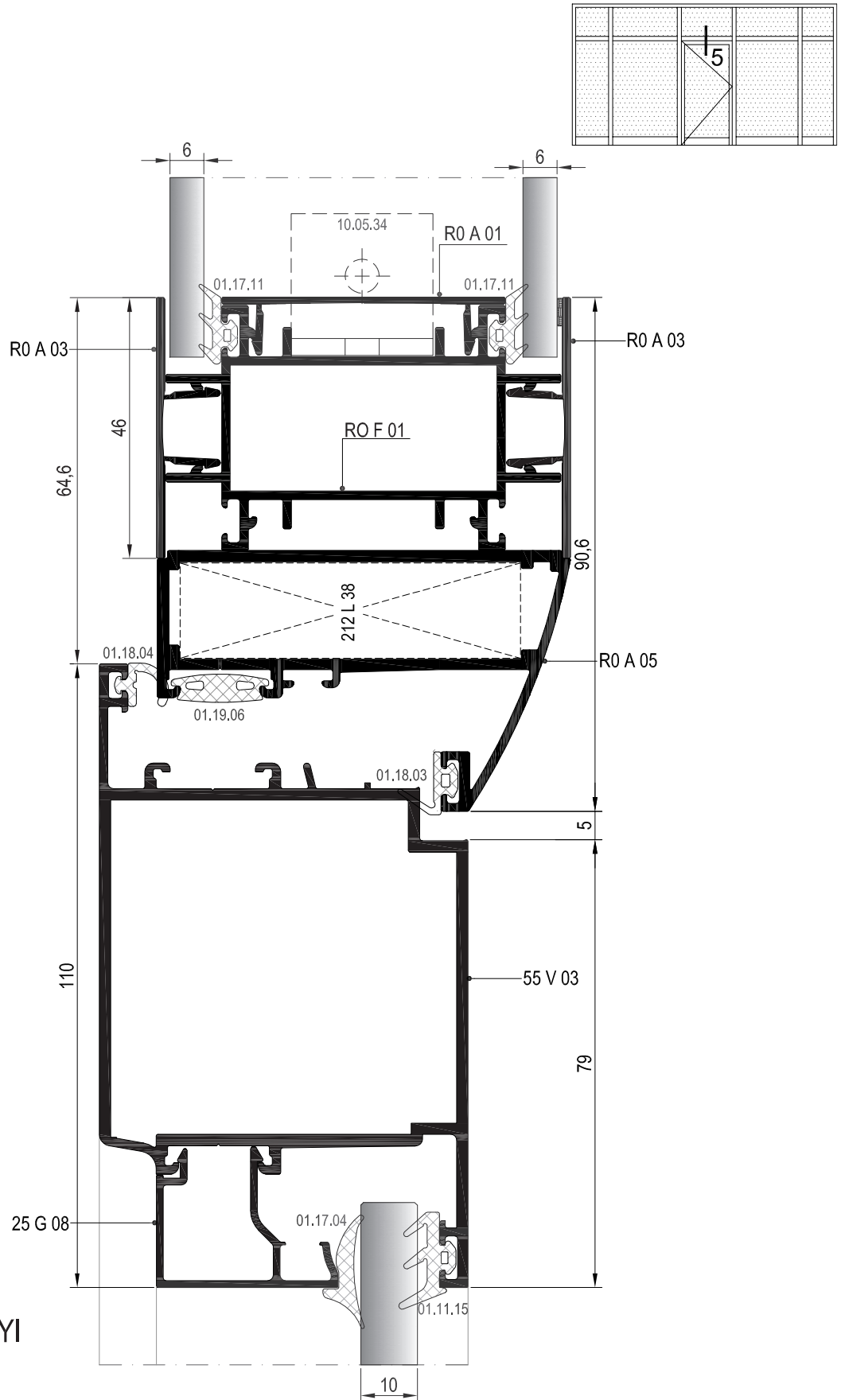

5 DETAYI  
DETAIL



# MİMARİ KATALOG

## ARCHITECTURAL CATALOGUE

Alüminyum Kapı Pencere ve Giydirme Cephe Sistemleri  
Aluminium Window Doors and Facade Systems

# RO73

AKSESUARLAR

ACCESSORIES

01

02

03

04

05

06









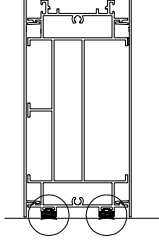

07

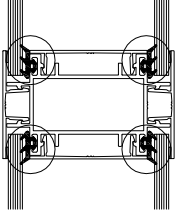
08

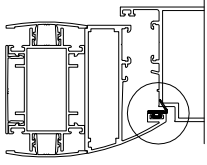
09

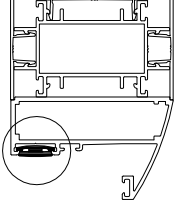
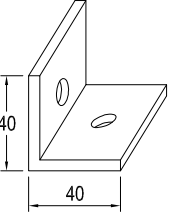
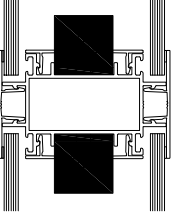
10

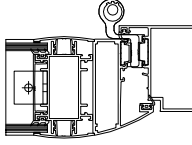
11

01		<p><b>01.07.08</b></p> <p>ETEK ALTI FITİLİ KICK PLATE GASKET</p> <p>Malzeme / Material : EPDM Ağırlık / Weight : 70 gr/m Paket / Package: 214m / 15 kg</p>				
02						
03		<p><b>01.17.11</b></p> <p>CAM FITİLİ GLAZING GASKET</p> <p>Malzeme / Material : EPDM Ağırlık / Weight : 235 gr/m Paket / Package: 63,8 m / 15 kg</p>				
04						
05		<p><b>01.18.03</b></p> <p>DIŞ BİNI FITİLİ OUTSIDE ACOUSTICAL GASKET</p> <p>Malzeme / Material : EPDM Ağırlık / Weight : 41 gr/m Paket / Package: 365 m / 15 kg</p>				
06						
07		<p><b>01.19.06</b></p> <p>ÇITA KANAL FITİLİ ADAPTER GASKET</p> <p>Malzeme / Material : EPDM Ağırlık / Weight : 80 gr/m Paket / Package: 185 m / 15 kg</p>				
08		<p><b>10.05.34</b></p> <p>BAĞLANTI PARÇASI CONNECTION PIECE</p> <p>ALÜMİNYUM 25 mm</p>				
09						
10		<p><b>15.02.09</b></p> <p>YERLİ KAPI MENTEŞESİ LOCAL HINGE FOR DOORS</p> <p>Renk: Siyah-Beyaz-Gri-Eloksal Color: Black-White-Grey-Anodised</p> <p>85kg için 3adet kullanılmalıdır./Should be used 3 for 85kg. Max.kanat ölçüsü 900x2200./Max.vent dimension 900x2200</p>				
11		<p><b>15.02.14</b></p> <p>GIESSE KAPI MENTEŞESİ GIESSE HINGE FOR DOORS</p> <p>Renk: Siyah-Beyaz-Gri-Eloksal Color: Black-White-Grey-Anodised</p> <p>100kg için 2adet, 120kg için 3adet kullanılmalıdır./Should be used 2for 100kg, 3for 120kg. EN 1935</p>	