



POWER FEEL

REPF160

Tasarımı Hisset
Feel The Design



ASAŞ HAKKINDA

Kurulduğu 1990 yılından beri istikrarlı büyüme trendi ile Türkiye'de İSO 500'de ilk 100 şirket arasında yer alan, aynı zamanda Avrupa'daki lider üreticilerden biri olan ASAŞ; 80'i aşkın ülkeye ihracat yapmakta, grup bünyesinde 2400'den fazla çalışanı ile Sakarya'da 300.000m² alanı kapalı olmak üzere; toplamda 750.000m² bir alanda, en modern teknoloji ile donatılmış tesislerinde üretim faaliyetlerini yürütmektedir.

ASAŞ çok sayıda başarılı iş birimlerini ve üretim tesislerini tek çatı altında bulundurmaktadır:

- Alüminyum Ekstrüzyon (Eloksallı, Elektrostatik Toz Boyalı, Mekanik İşlemlili Profiller)
- Alüminyum Yassı Mamuller (Levha, Rulo, Folyo, Boyalı Rulo)
- Alüminyum Mimari Sistemler
- Alüminyum Kompozit Panel (Giydirme, Cephe, Cephe Kaplaması ve Reklam Uygulamaları)
- PVC Kapı ve Pencere Sistemleri
- Panjur ve Kepenk Sistemleri
- Alüminyum Tasarım Ürünleri (Bayrak Direkleri, Aydınlatma Direkleri, Raf Sistemleri)
- ASAŞSANAT (Sanatçılar, Akademisyen ve Öğrenciler için yaratıcı bir platform)

ABOUT ASAŞ

Since its founding in 1990, ASAŞ has grown steadily and ranked among Turkey's Top 100 Industrial Companies List and one of Europe's leading manufacturing companies. ASAŞ is currently; exporting to over 80 countries, employing over 2400 highly skilled people across the group and operates in a 750.000m² site in Sakarya / Turkey, of which 300.000m² is closed and equipped with the latest technology.

ASAŞ currently includes a number of highly successful business units and production facilities under the same roof:

- Aluminium Extrusion (anodized, powder coated, machined profiles)
- Aluminium Flat Rolled Products (sheet, coil, foil, coated coil)
- Aluminium Architectural Systems
- Aluminium Composite Panel (for facade, cladding and signboards)
- PVC Window and Door Systems
- Roller Shutter and Steel Shutter Systems
- Aluminium Design Products (flag poles, lighting poles, shelf systems)
- ASAŞART (creative platform for artists, academicians and students)

Yüksek performans gerektiren projelerde kullanılan sıkıca mühürlenmiş akıllı kapanma sistemine sahip, sessiz ve kolay kullanımlı mekanizması olan sürme sistemi.

Silent and easy-to-use drive system with a tightly sealed intelligent closing system for high-performance projects.

SÜRME DOĞRAMA
SİSTEMLERİNDE
YENİLİKÇİ
TASARIM
INNOVATIVE
DESIGN IN
SLIDING WINDOW
SYSTEMS



Power Feel REPF160 sistemi, yüksek kalite standardına sahip ekonomik ve modern donanım çözümü sunar. Kolay kilitleme sistemi ile basit kullanımlıdır.

The Power Feel REPF160 system provides an economical and modern hardware solution with a high quality standard.



Power Feel REPF160, farklı aksesuar yapısı sayesinde yüksek nitelikli mimari taleplere yanıt verebilen sürme kapı ve pencere sistemidir.

The **Power Feel REPF160** is a sliding door and window system that can meet highly qualified architectural demands thanks to its various accessory structure.





Mevcut sürme sistemlerinden daha üstün bir ses yalıtımı sunan Power Feel geri dönüşümlü malzemelerden üretildiği için sürdürülebilir bir yapı malzemesi olarak karşımıza çıkmaktadır.

Power Feel REPF160 has better sound insulation on other sliding systems, is produced from recycled materials and therefore it is a sustainable building material as well.

Uygulama Seçenekleri / Installation Types

Sürme pencere örnekleri / Types of sliding panels

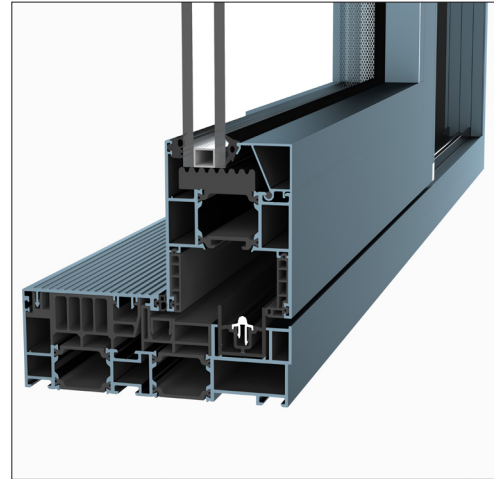
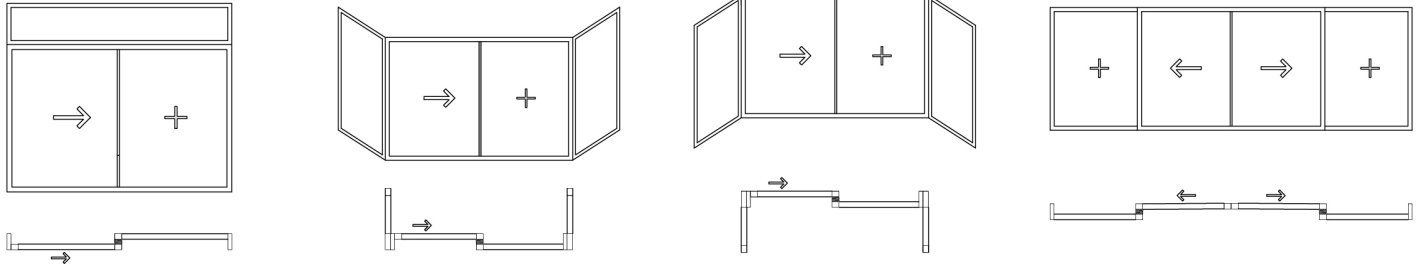

REPF160 bir ya da iki hareketli kanatlı ve farklı uygulama versiyonlu sürme kapı ve pencereler için uygundur.
REPF160 is suitable for sliding windows and doors with one or two movable sashes and different mounting versions.

Açma, Sürme ve Kapatmada Daha Fazla Konfor / More Comfort in Opening, Sliding and Closing

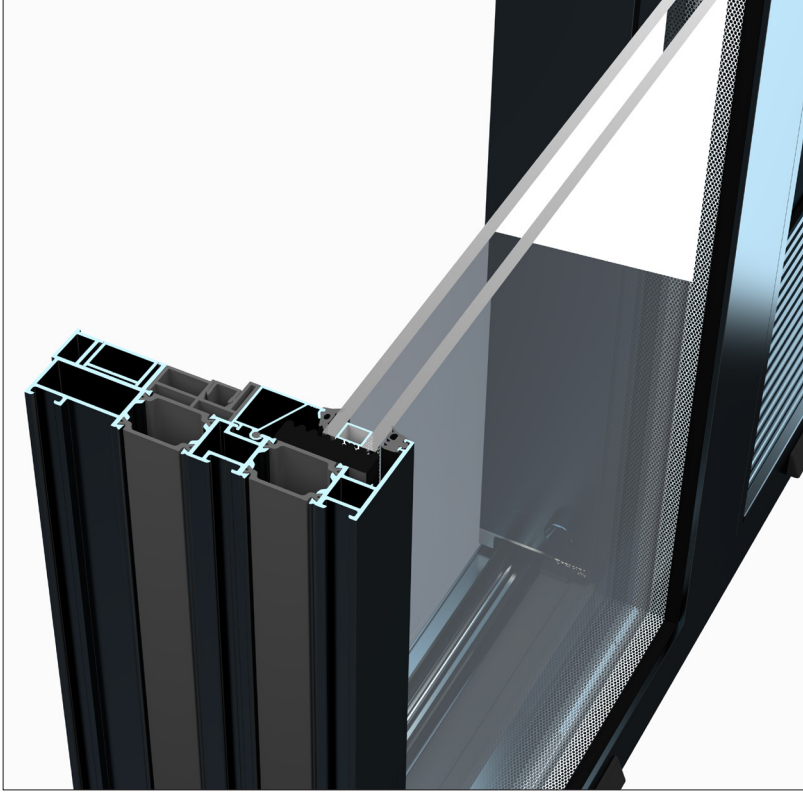

Kolun kolay çalıştırılması sayesinde ağır kanatlarda bile kolay kullanım.

Convenient opening even with heavy sashes thanks to the easy operation of the handle.

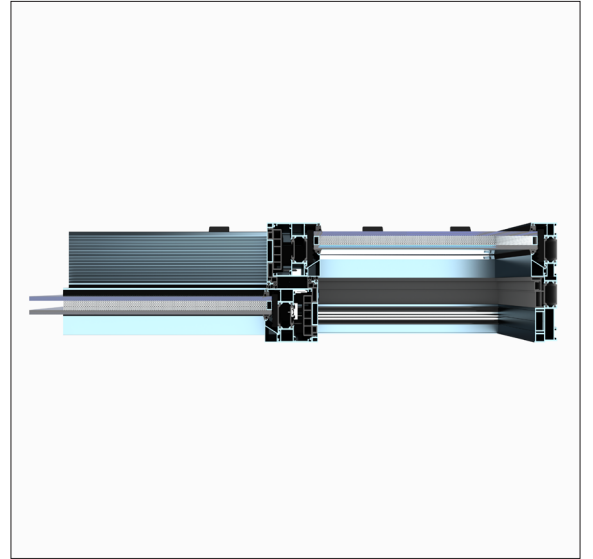
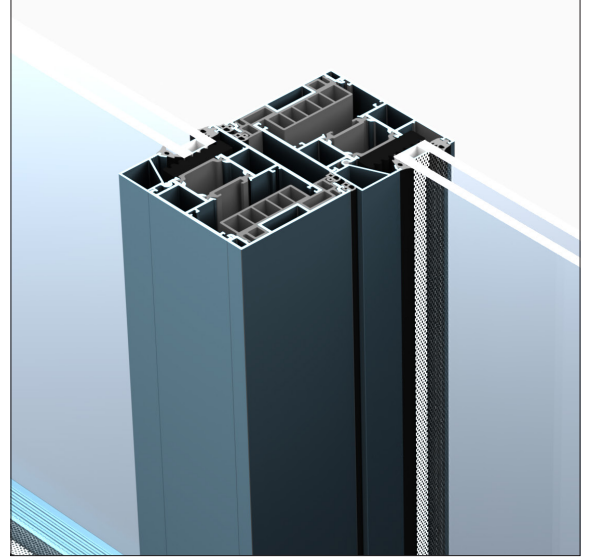

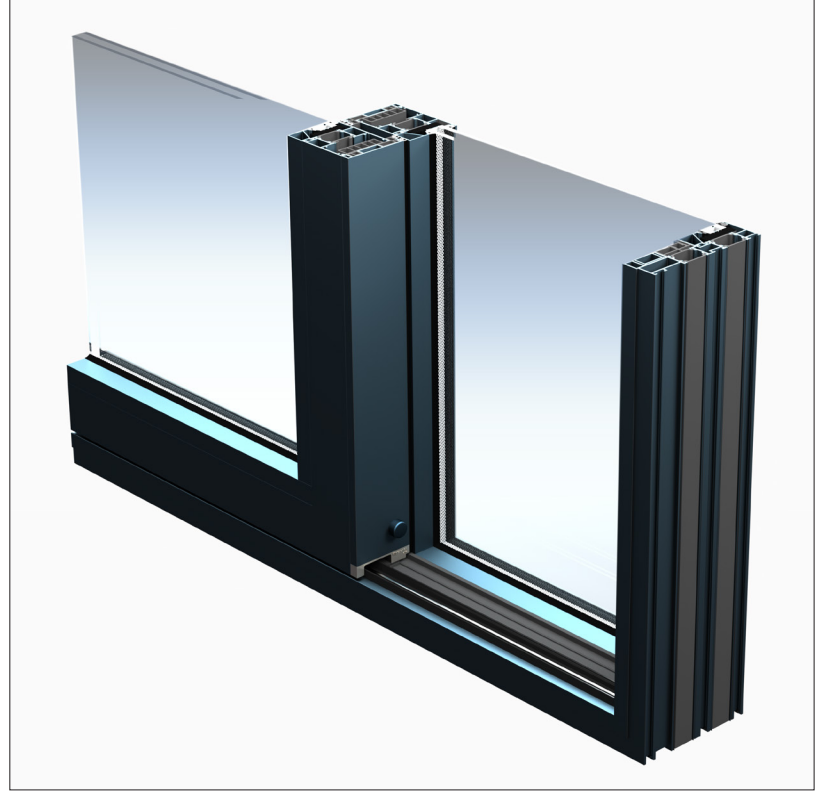
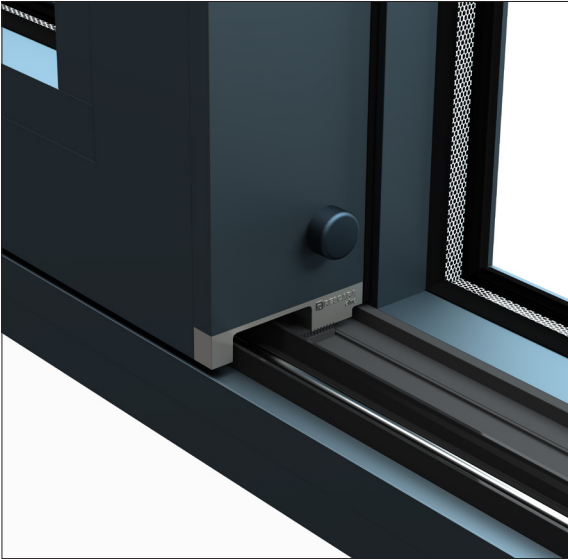
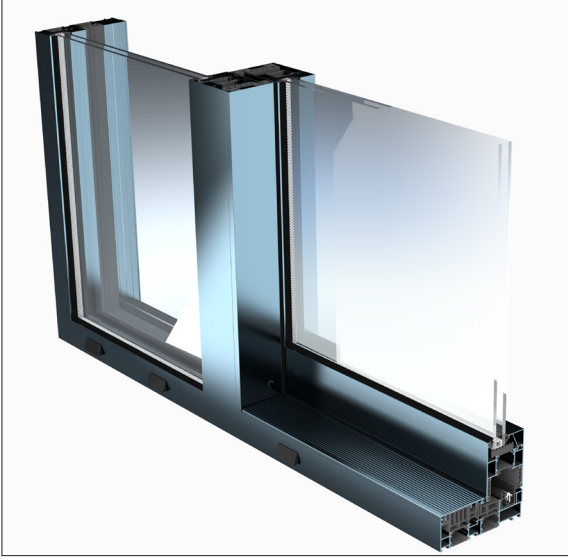

Kanat çerçevesinde bulunan özel aksesuar sayesinde kolay kapanma.

Easy closing thanks to the gentle special device in the sash frame.

Mimari Talepleri Karşılayan Konfor / Comfort to Meet Architectural Expectations

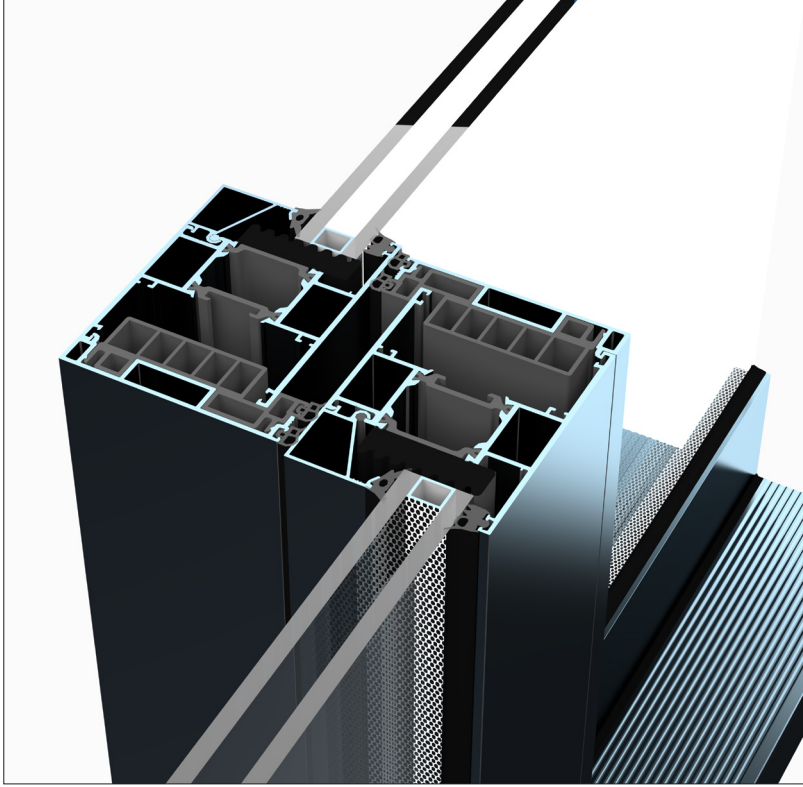

Aynı anda 4 taraftan kontrol edilebilen kilitleme noktaları ile kapanma hareketi.

Uniform closing movement with positive control through locking points controlled on all 4 sides.

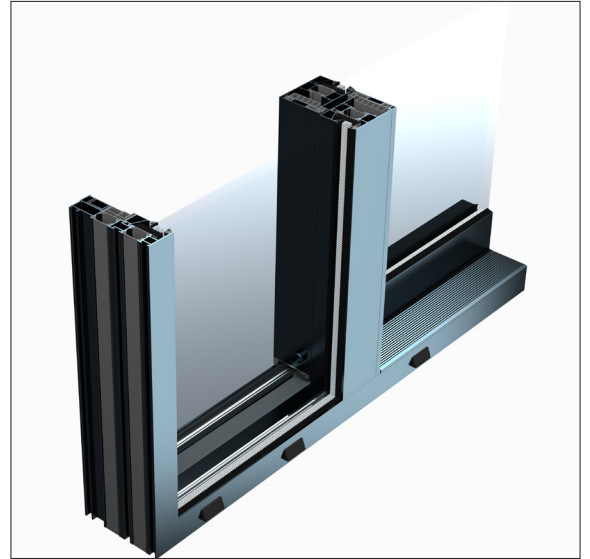
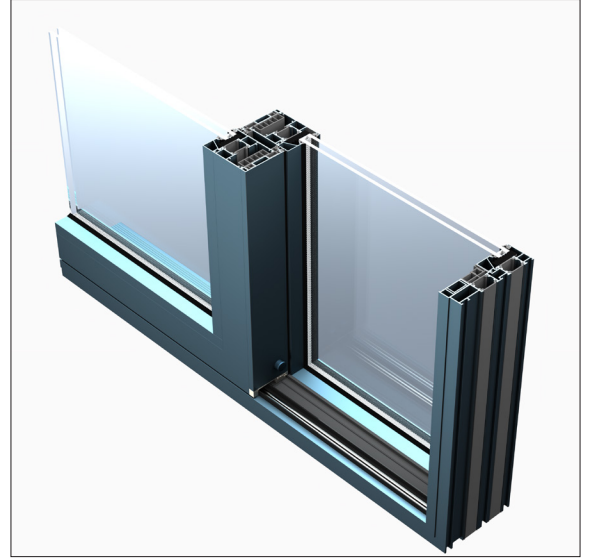





REPF160 kapı ve pencere sızdırmazlığının talep edildiği yüksek rüzgar yüklerine maruz kalan binalarda kullanım için idealdir.

When it comes to window and door tightness **REPF160** is ideal for use in high-rise buildings where high wind loads occur.

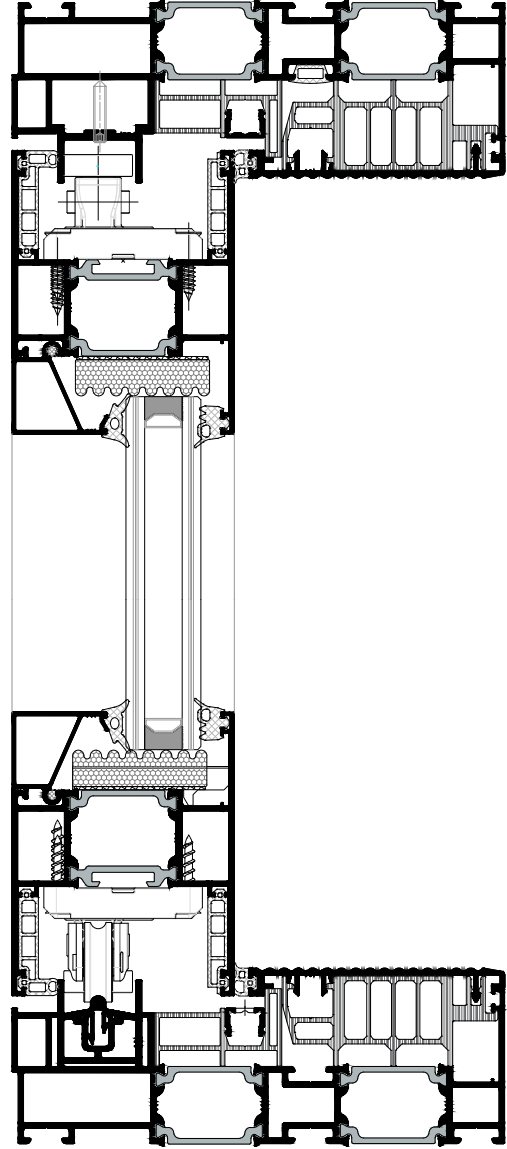

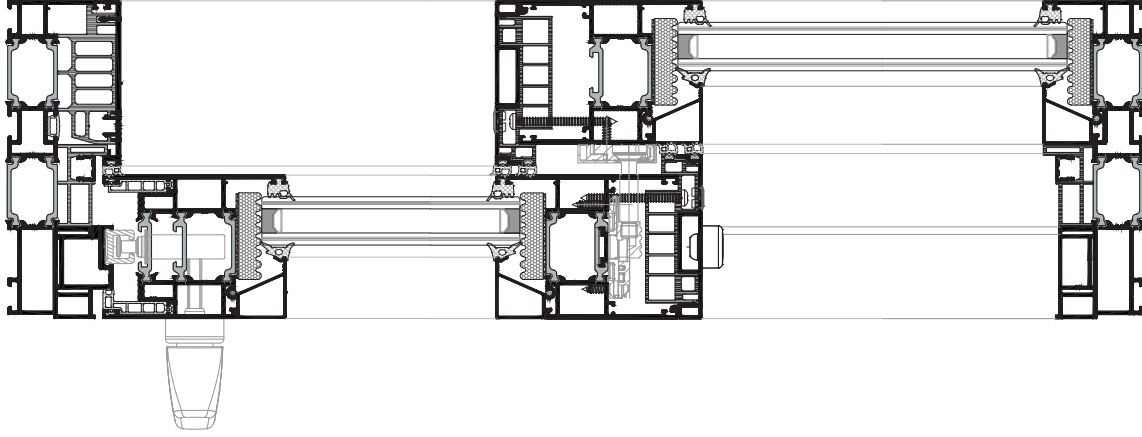

Teknik Bilgi / Technical Data



Her sürme kanat maks.
200 kg taşır / Each panel can
carry up to 200 kg

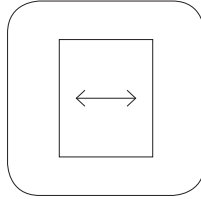

Sürme panelin maks. genişliği
1500 mm / Max width for each
panel is 1500 mm

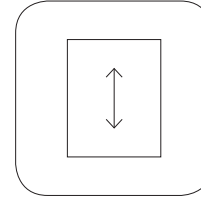

Maks. yükseklik 2500 mm /
Max height is 2500 mm

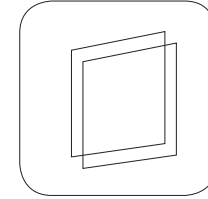

Maks. cam kalınlığı 28 mm /
Max glass width is 28 mm

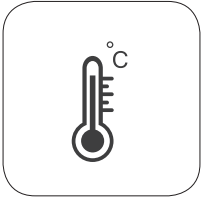

Isı geçirgenliği $U_w = 1.8 \text{ W/m}^2\text{K}$ /
Thermal insulation
 $U_w = 1.8 \text{ W/m}^2\text{K}$

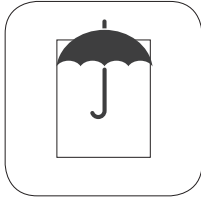

Hava geçirgenliği A4 (600 Pa) /
Air permeability is A4 (600 Pa)

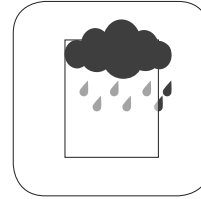

Su geçirgenliği E750 (750 Pa) /
Water permeability is
E750 (750 Pa)

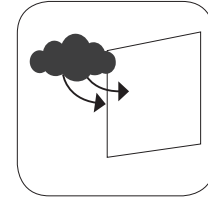

Rüzgar yükü dayanıklılığı
C4 (1600 Pa) / Wind load
resistance is C4 (1600 Pa)



ASAŞ Alüminyum Sanayi ve Ticaret A.Ş.

Genel Müdürlük / Headquarters

Rüzgarlı Bahçe Mah., Kumlu Sok., No: 2

Asaş İş Merkezi, 34810 Kavacık

Beykoz - İstanbul, Türkiye

T +90 216 680 07 80 F +90 216 680 07 81

asastr.com

Alüminyum Profil ve Kompozit Panel

Üretim Tesisleri / Aluminium Profile and Composite

Panel Production Facilities

Küçücek İstiklal Mah., Kışla Alanı Cad.,

No:2-2/1, 54400 Akyazı - Sakarya, Türkiye

T +90 264 462 47 92 F +90 264 462 47 96