



REFD77

Katlanır Kapı Sistemi
Folding Door System

Alüminyum Mimari Sistemler
Aluminium Architectural Systems





ASAŞ HAKKINDA

Kurulduğu 1990 yılından beri istikrarlı büyüme trendi ile Türkiye’de ISO 500’de ilk 100 şirket arasında yer alan, aynı zamanda Avrupa’daki lider üreticilerden biri olan ASAŞ; 6 kıtada 90’dan fazla ülkeye ihracat yapmakta, grup bünyesinde 3.000’den fazla çalışanı ile Sakarya’da 400.000m² alanı kapalı olmak üzere; toplamda 1.000.000 m² bir alanda, en modern teknoloji ile donatılmış tesislerinde üretim faaliyetlerini yürütmektedir.

ASAŞ çok sayıda başarılı iş birimlerini ve üretim tesislerini tek çatı altında bulundurmaktadır:

- Alüminyum Ekstrüzyon (eloksallı, elektrostatik toz boyalı, mekanik işlemlerli profiller)
- Alüminyum Yassı Mamuller (levha, rulo, folyo, boyalı rulo)
- Alüminyum Mimari Sistemler
- Alüminyum Kompozit Panel (giydirme cephe, cephe kaplaması ve reklam uygulamaları)
- PVC Kapı ve Pencere Sistemleri
- Panjur Sistemleri
- Alüminyum Tasarım Ürünleri (bayrak direkleri, aydınlatma direkleri, raf sistemleri)
- ASAŞSANAT (sanatçılar, akademisyen ve öğrenciler için yaratıcı bir platform)

ABOUT ASAŞ

Since its founding in 1990, ASAŞ has grown steadily and ranked among Turkey's Top 100 Industrial Companies List and one of Europe's leading manufacturing companies. ASAŞ is currently; exporting to over 90 countries on 6 continents, employing over 3000 highly skilled people across the group and operates in a 1.000.000m² site in Sakarya / Turkey, of which 400.000m² is closed and equipped with the latest technology.

ASAŞ currently includes a number of highly successful business units and production facilities under the same roof:

- Aluminium Extrusion (anodized, powder coated, machined profiles)
- Aluminium Flat Rolled Products (sheet, coil, foil, coated coil)
- Aluminium Architectural Systems
- Aluminium Composite Panel (for facade, cladding and signboards)
- PVC Window and Door Systems
- Roller Shutter Systems
- Aluminium Design Products (flag poles, lighting poles, shelf systems)
- ASAŞART (creative platform for artists, academicians and students)



REFD77 Katlanır Kapı Sistemi, ASAŞ'ın tasarım, performans, esneklik ve güvenlik ihtiyaçlarını maksimum seviyede karşılama yönünde geliştirilmiş sistemdir.

Taşıyıcı rulmanların kanadın altında bulunması ile sürdürülebilir kalite ve konforu bir arada sunar.

REFD77 Folding Door System is developed by ASAŞ to meet requirements of design, performance, flexibility and security.

Provides sustainable quality and comfort together thanks to the location of the roller hinges at the bottom (in the rail).

REFD77 yükü alt kasaya aktaran makaralı mekanizma ve farklı ihtiyaçlara cevap verebilen kilit opsiyonları ile zarif,estetik ve uzun ömürlü çözümler sunar.

Bi-folding özelliği ile hem içe hem dışa açılım sağlar.

REFD77 offers elegant, aesthetic, and long-lasting solutions with a roller hinge mechanism transferring the load to the lower frame profile and lock options that can meet different needs.

With its bi-folding feature, provides both inward and outward opening.









Alt kasada konumlanmış taşıyıcı rulmanlar sayesinde 120 kg ağırlık ve 3,50 metre yüksekliğe kadar kanat yapılabilmesine imkan verir.

Çoklanabilir detay prensibi ve esnek kanat adetleri sayesinde geniş açıklıklar için uygun tipolojiler sunar.

REFD77 sistemi aksesuar altyapısının sunduğu avantaj ile her kanatta kilitleme imkanı sağlayarak güvenliği ön planda tutar.

Thanks to the carrier rollers positioned in the lower frame, it allows for building vents weighing up to 120 kg and reaching heights of up to 3.50 meters.

With the principle of multiplicity in details, it offers suitable typologies for wide openings thanks to flexible frame quantities.

The REFD77 system prioritizes the safety of you and your loved ones by providing locking on each vent with the advantage of a wide range of accessories.



REFD77 esnek tipolojileri ile tüm ihtiyaçları karşılayan; ticari binalar ve modern konutlarda geniş açıklıklar için güvenli ve konforlu açılım sunan yüksek performanslı yalıtımlı katlanır doğrama sistemidir.

Yüksek ısı yalıtım performansı ile soğuk iklim koşullarında rahatlıkla tercih edilebilir.

REFD77 is a high-performance insulated folding door system that meets all needs with its flexible typologies, offering secure and comfortable openings for long spans in commercial buildings and modern residences.

With its high thermal insulation performance, it can be comfortably preferred in cold climate conditions.



ISİ GEÇİRGENLİK THERMAL INSULATION	TİPOLOJİ TYPOLOGY	ÖLÇÜLER DIMENSIONS (L X H)	Uw in W/ m ² K (Ug=0,6)	Uw in W/ m ² K (Ug=0,8)	Uw in W/ m ² K (Ug=1,1)
	<p>3+1</p>	3.0 x 3.0 m	1,25	1,39	1,66
		3.3 x 3.0 m	1,21	1,35	1,62
		3.3 x 3.15 m	1,20	1,34	1,61



- Hemyüz ve binili detaylar ile farklı dekoratif tercihlere hizmet edebilir.
- 24mm ve 50 mm arasında değişebilen cam kalınlıkları ile 2 ve 3lü cam kombinasyonlarının kullanımına imkan verir.
- It can serve various decorative options with flush and overlapping details.
- It allows the use of double and triple glazing combinations with glass thicknesses that can vary between 24 mm and 50 mm.



Teknik Özellikler / Technical Properties

KASA DERİNLİĞİ FRAME DEPTH	77 mm
KANAT DERİNLİĞİ VENT DEPTH	65 mm
CAM KALINLIĞI GLASS THICKNESS	24 - 28 - 32 - 36 - 50 mm
BARİYER GENİŞLİĞİ THERMAL BARRIER	24 - 31 mm
MAX. KANAT YÜKSEKLİĞİ MAX. VENT HEIGHT	3,5 m
MAX. KANAT TAŞIMA KAPASİTESİ MAX. VENT WEIGHT	120 kg

Performans Değerleri / Performance Values

 HAVA GEÇİRGENLİĞİ AIR PERMEABILITY	A4 600Pa
 SU SIZDIRMAZLIĞI WATERTIGHTNESS	8A 450Pa
 RÜZGAR YÜKÜNE DAYANIM RESISTANCE TO WIND LOAD	C3 1200Pa

Teknik Veriler Technical Sheet



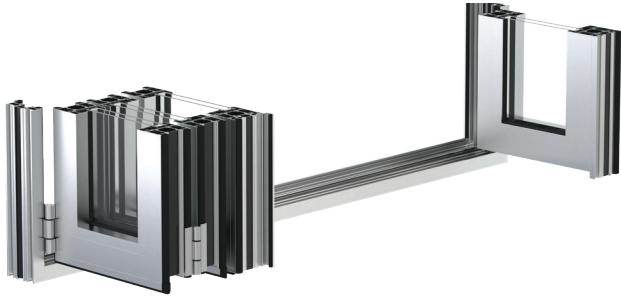

Geleneksel katlanır sistemlere göre daha büyük ve ağır kanatlar yapılabildiği gibi gizli mekanizma parçaları ile şık, zarif ve dekoratif görünümlüdür.

Larger and heavier vents can be built compared to conventional folding systems, and it looks stylish, elegant and decorative with its hidden mechanism parts.



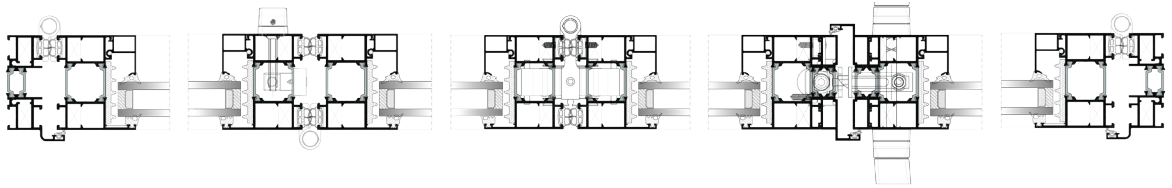
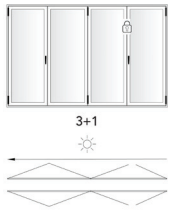

2 KANAT
2 VENT

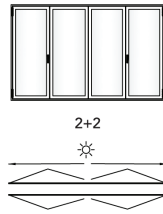
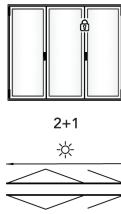
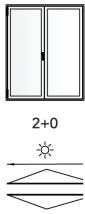

6 KANAT
6 VENT

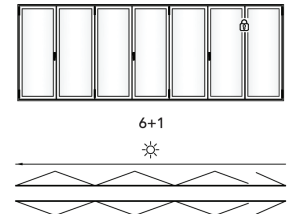
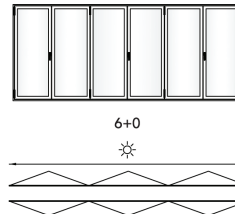

3 KANAT
3 VENT

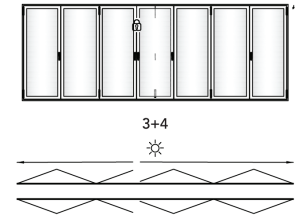
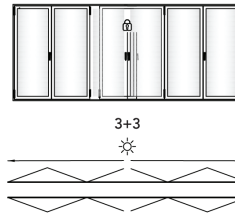
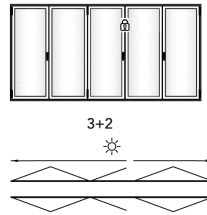
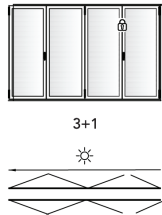
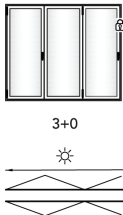

4 KANAT
4 VENT

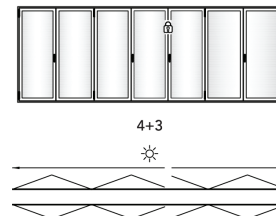
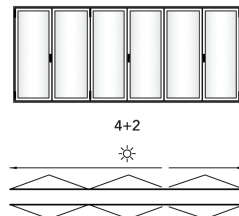
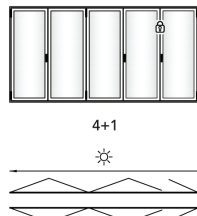
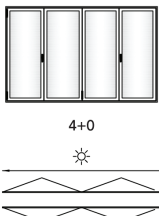







ASAŞ Alüminyum Sanayi ve Ticaret A.Ş.

Genel Müdürlük / Headquarters
Rüzgarlı Bahçe Mah., Kumlu Sok., No: 2
Aşaş İş Merkezi, 34810 Kavacık
Beykoz - İstanbul, Türkiye
T +90 216 680 07 80 F +90 216 680 07 81

asasttr.com
asasarchitect.com.tr

ASAS GmbH

Rasselsteiner Str. 101
56564 Neuwied, Deutschland
T +49 (0) 2631 90209-20
F +49 (0) 2631 90209-11