



POWER FEEL REPF160

Tasarımı Hisset
Feel The Design





ASAŞ HAKKINDA

Kurulduğu 1990 yılından beri istikrarlı büyüme trendi ile Türkiye’de İSO 500’de ilk 100 şirket arasında yer alan, aynı zamanda Avrupa’daki lider üreticilerden biri olan ASAŞ; 80’i aşkın ülkeye ihracat yapmakta, grup bünyesinde 3000’den fazla çalışanı ile Sakarya’da 400.000 m² alanı kapalı olmak üzere; toplamda 1.000.000 m² bir alanda, en modern teknoloji ile donatılmış tesislerinde üretim faaliyetlerini yürütmektedir.

ASAŞ çok sayıda başarılı iş birimlerini ve üretim tesislerini tek çatı altında bulundurmaktadır:

- Alüminyum Ekstrüzyon (eloksallı, elektrostatik toz boyalı, mekanik işlemleri profiller)
- Alüminyum Yassı Mamuller (levha, rulo, folyo, boyalı rulo)
- Alüminyum Mimari Sistemler
- Alüminyum Kompozit Panel (giydirme cephe, cephe kaplaması ve reklam uygulamaları)
- PVC Kapı ve Pencere Sistemleri
- Panjur Sistemleri
- Alüminyum Tasarım Ürünleri (bayrak direkleri, aydınlatma direkleri, raf sistemleri)
- ASAŞANAT (sanatçılar, akademisyen ve öğrenciler için yaratıcı bir platform)

ABOUT ASAŞ

Since its founding in 1990, ASAŞ has grown steadily and ranked among Turkey’s Top 100 Industrial Companies List and one of Europe’s leading manufacturing companies. ASAŞ is currently; exporting to over 80 countries, employing over 3000 highly skilled people across the group and operates in a 1.000.000 m² site in Sakarya / Turkey, of which 400.000 m² is closed and equipped with the latest technology.

ASAŞ currently includes a number of highly successful business units and production facilities under the same roof:

- Aluminium Extrusion (anodized, powder coated, machined profiles)
- Aluminium Flat Rolled Products (sheet, coil, foil, coated coil)
- Aluminium Architectural Systems
- Aluminium Composite Panel (for facade, cladding and signboards)
- PVC Window and Door Systems
- Roller Shutter Systems
- Aluminium Design Products (flag poles, lighting poles, shelf systems)
- ASAŞART (creative platform for artists, academicians and students)



Yüksek performans gerektiren projelerde kullanılan sıkıca mühürlenmiş akıllı kapanma sistemine sahip, sessiz ve kolay kullanımlı mekanizması olan sürme sistemi.

Silent and easy-to-use drive system with a tightly sealed intelligent closing system for high-performance projects.

SÜRME DOĞRAMA
SİSTEMLERİNDE YENİLİKÇİ
TASARIM
INNOVATIVE DESIGN IN
SLIDING WINDOW SYSTEMS





Power Feel REPF160 sistemi, yüksek kalite standardına sahip ekonomik ve modern donanım çözümü sunar. Kolay kilitleme sistemi ile basit kullanımlıdır. Klasik sürme sistemleri klasmanında yeni bir standart ve tür oluşturmuştur.

The Power Feel REPF160 system provides an economical and modern hardware solution with a high quality standard. Easy to use with simple locking system. It has created a new standard and type in the classic driving system class.

Power Feel REPF160, farklı aksesuar yapısı sayesinde yüksek nitelikli mimari taleplere yanıt verebilen sürme kapı ve pencere sistemidir.

The **Power Feel REPF160** is a sliding door and window system that can meet highly qualified architectural demands thanks to its various accessory structure.



Mevcut sürme sistemlerinden daha üstün bir ses yalıtımı sunan Power Feel geri dönüşümlü malzemelerden üretildiği için sürdürülebilir bir yapı malzemesi olarak karşımıza çıkmaktadır.

Power Feel REPF160 has better sound insulation on other sliding systems, is produced from recycled materials and therefore it is a sustainable building material as well.

Uygulama Seçenekleri / Installation Types

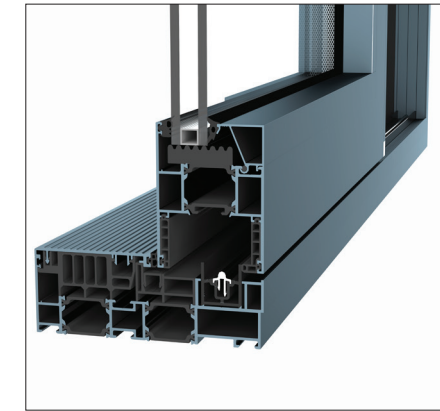
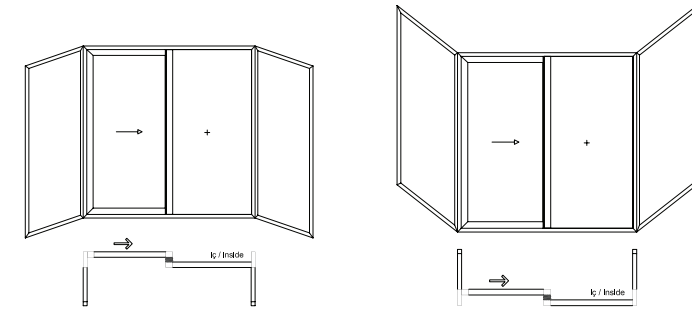
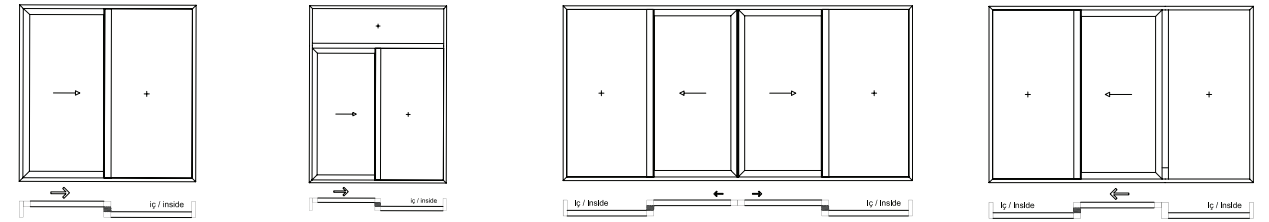

REPF160 bir ya da iki hareketli kanatlı, monoraylı sürme kapı ve pencereler için uygundur.
REPF160 is convenient for mono railed sliding doors and windows with one or two moving vents.

Açma, Sürme ve Kapatmada Daha Fazla Konfor / More Comfort in Opening, Sliding and Closing

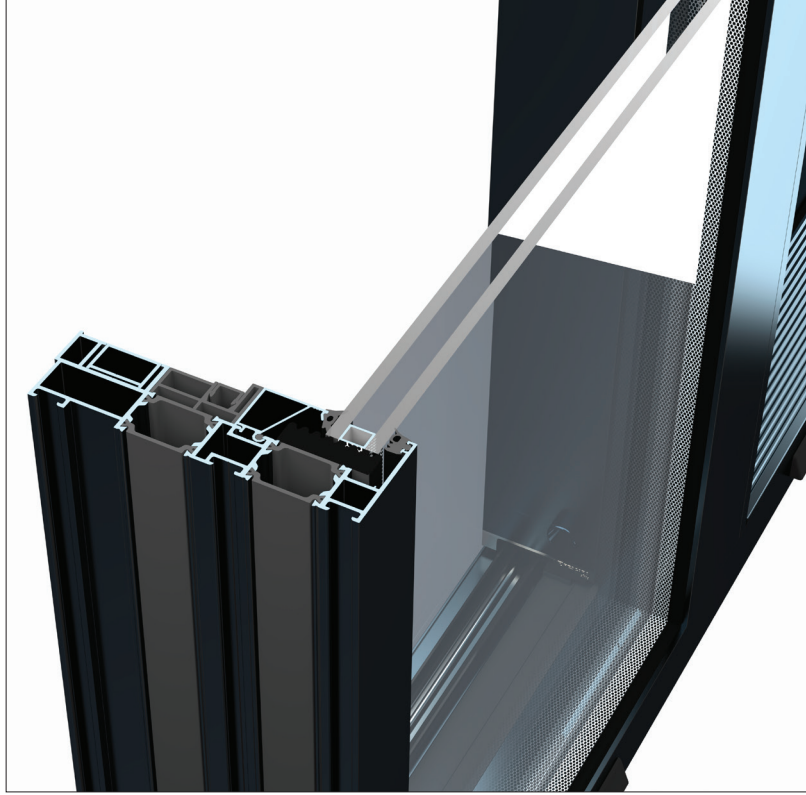

Kolay çalışan kol ile ağır kanatlarda bile efektif kullanım.
Effective use even on heavy vents with the easily moved handle.

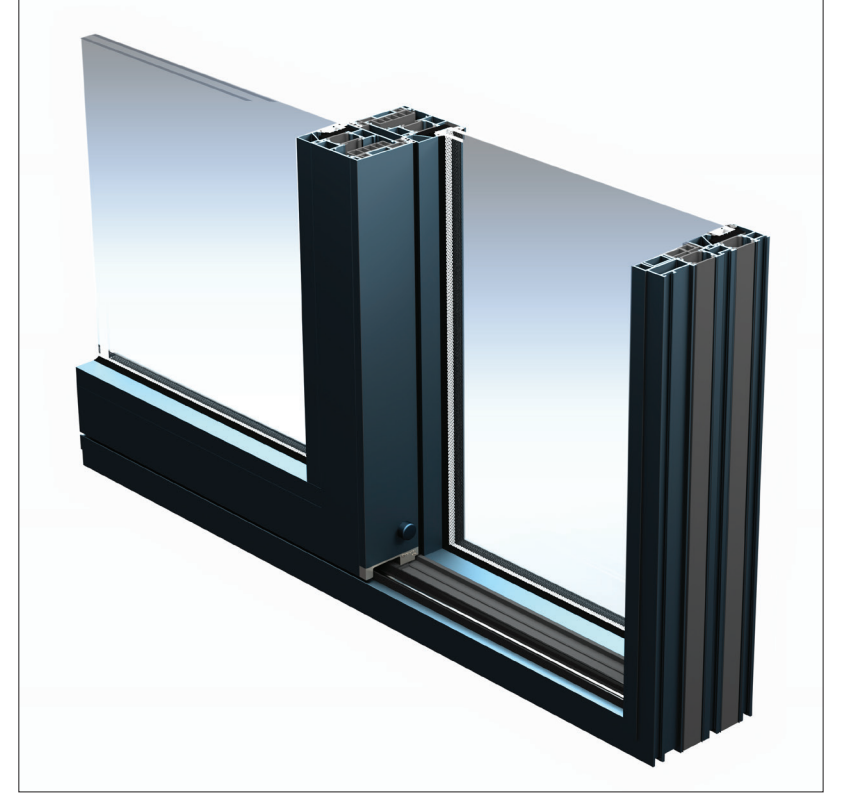
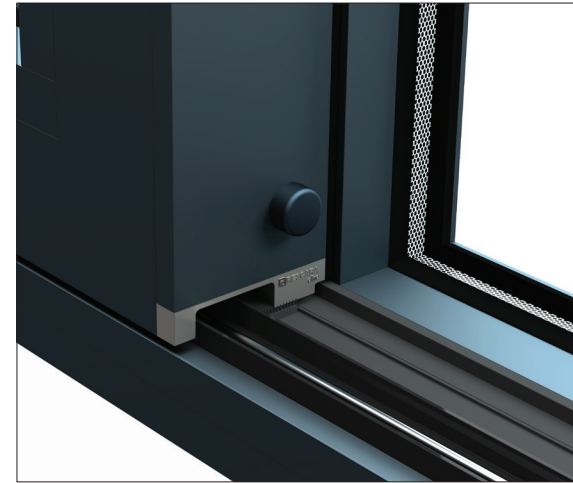
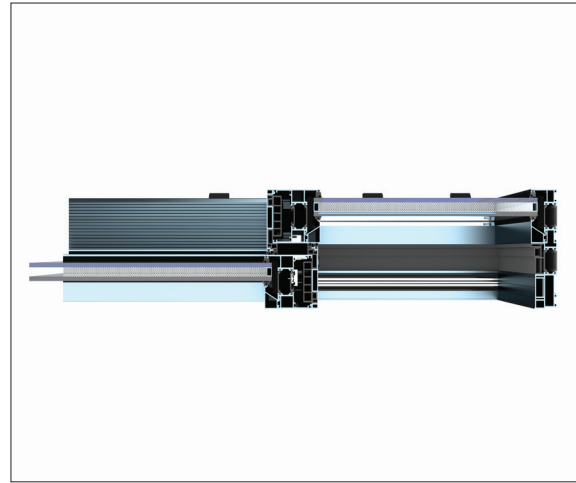
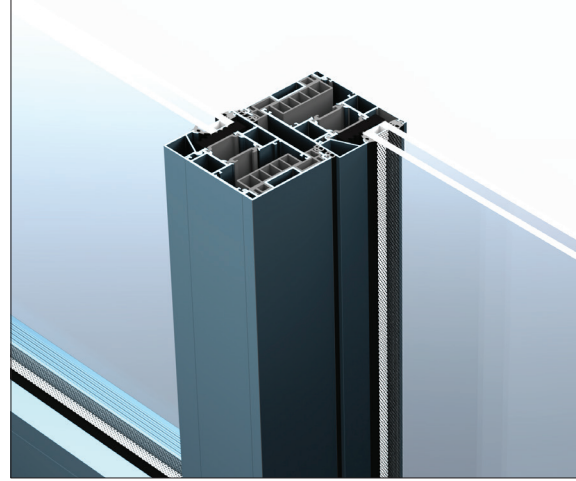

Kanat çerçevesinde bulunan özel aksesuar sayesinde kolay ve etkili kapanma.
Easy and effective closing thanks to the exclusive accessory located on the vent frame.

Easy and effective closing thanks to the exclusive accessory located on the vent frame.

Mimari Talepleri Karşlayan Konfor / Comfort to Meet Architectural Expectations

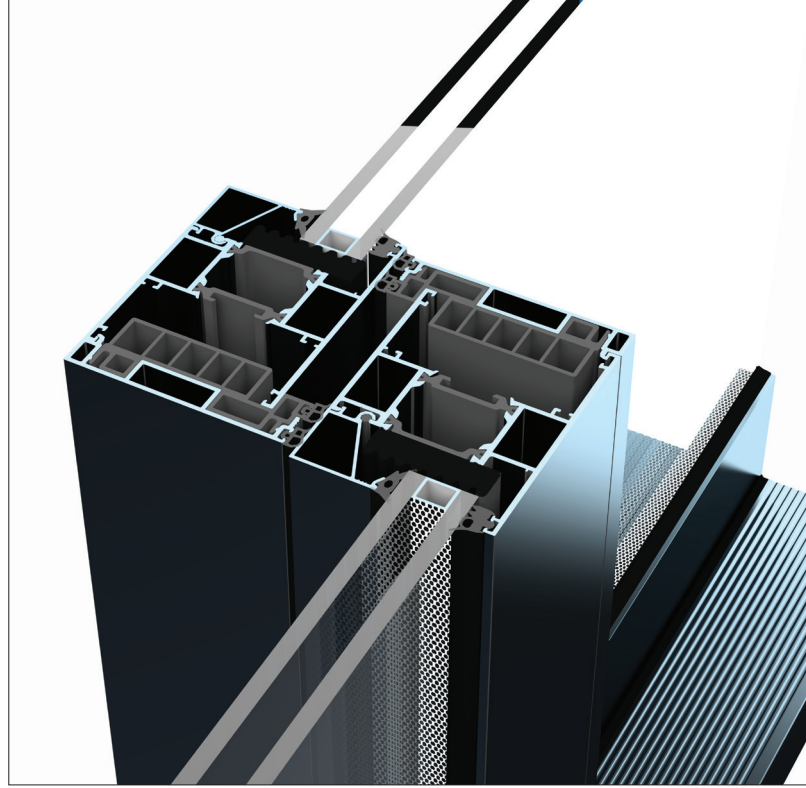

Aynı anda dört taraftan kontrol edilebilen kilitleme noktaları ile tam kapanma hareketi.

Simultaneous four side control for complete closing.

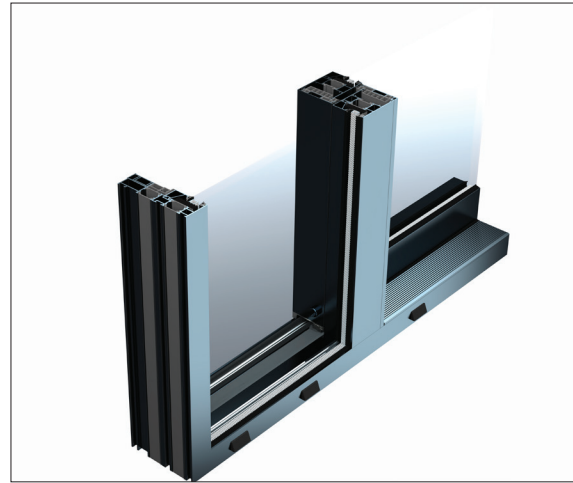
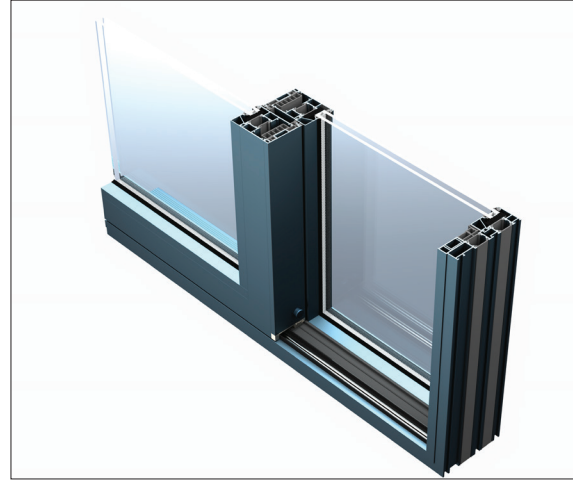



REPF160 kapı ve pencere sızdırmazlığının talep edildiği yüksek rüzgar yüklerine maruz kalan binalarda kullanım için idealdir.

When it comes to window and door tightness **REPF160** is ideal for use in high-rise buildings where high wind loads occur.

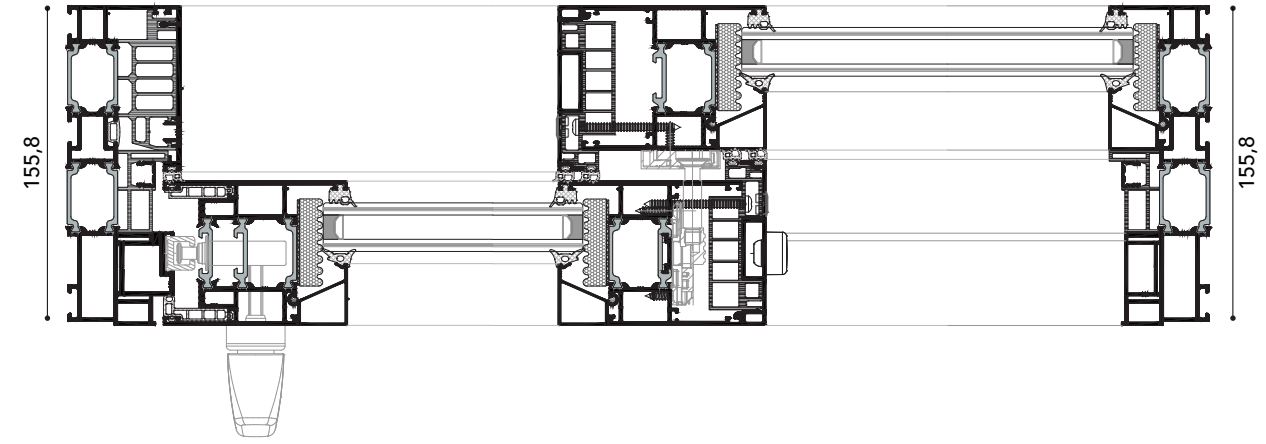
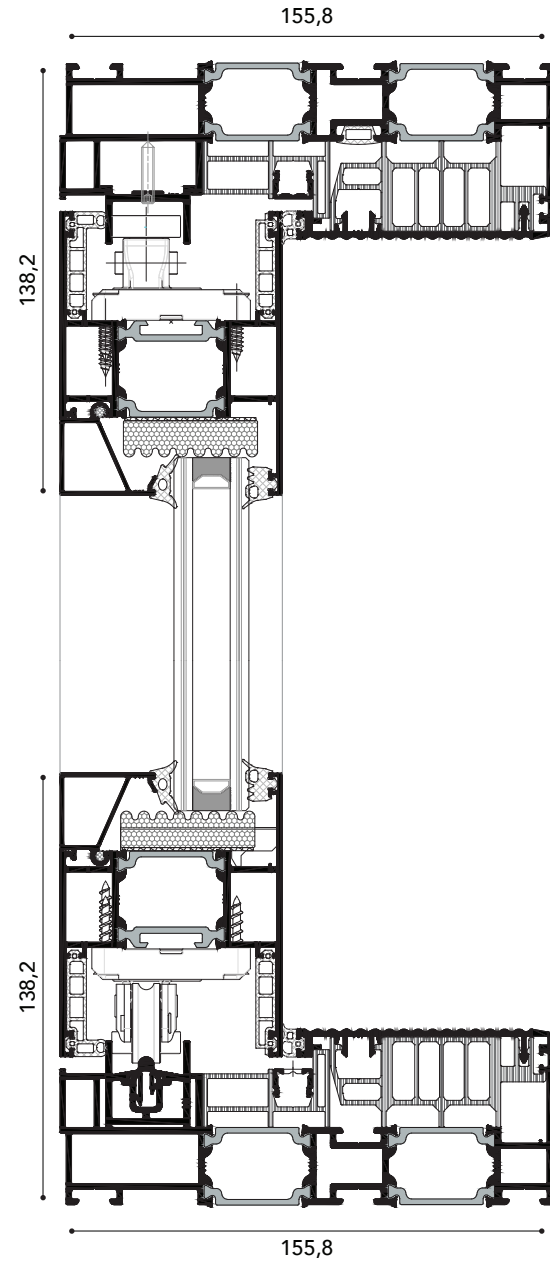

Teknik Özellikler / Technical Properties





KASA DERİNLİĞİ FRAME DEPTH	157,8 mm
KANAT DERİNLİĞİ VENT DEPTH	71,2 mm
PROFİL ET KALINLIĞI PROFILE WALL THICKNESS	1,7 / 1,8 / 2 mm
MAX. CAM KALINLIĞI MAX. GLASS THICKNESS	52 mm
ISI BARIYERİ THERMAL BREAK	34 mm



Uygulama Alanı / Application Areas

←→	KANAT GENİŞLİĞİ (SW) SASH WIDTH	600 - 2000 mm	1500 - 3000 mm
↑ ↓	KANAT YÜKSEKLİĞİ (SH) SASH HEIGHT	1000 - 3000 mm	2000 - 3600 mm
KG	KANAT AĞIRLIĞI (S. kg) SASH WEIGHT	Max. 200 kg	Max. 400 kg

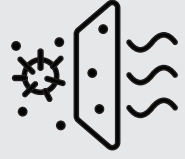
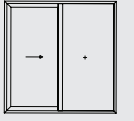

Performans Değerleri / Performance Values

	HAVA GEÇİRGENLİĞİ AIR PERMEABILITY	A4 600Pa
	SU SIZDIRMAZLIĞI WATERTIGHTNESS	E750
	RÜZGAR YÜKÜNE DAYANIM RESISTANCE TO WIND LOAD	C4 1600Pa
	SES YALITIMI ACOUSTIC PERFORMANCE VALUE	33,7 dB

ISI GEÇİRGENLİK THERMAL INSULATION	TİPOLOJİ TYPOLOGY	ÖLÇÜLER DIMENSIONS (L X H)	Uw in W/ m ² K (Ug=0,6)	Uw in W/ m ² K (Ug=0,8)	Uw in W/ m ² K (Ug=1,1)
		2.8 x 2.8 m	0,98	1,14	1,43
		5.6 x 2.8 m	1.01	1.17	1.47





ASAŞ Alüminyum Sanayi ve Ticaret A.Ş.

Genel Müdürlük / Headquarters
Rüzgarlı Bahçe Mah., Kumlu Sok., No: 2
Asaş İş Merkezi, 34810 Kavacık
Beykoz - İstanbul, Türkiye

T +90 216 680 07 80 F +90 216 680 07 81

asastr.com

asasarchitecture.com.tr

ASAS GmbH

Rasselsteiner Str. 101
56564 Neuwied, Deutschland
T +49 (0) 2631 90209-20
F +49 (0) 2631 90209-11